

Tutorials



ANSYS, Inc.
Southpointe
275 Technology Drive
Canonsburg, PA 15317
ansysinfo@ansys.com
<http://www.ansys.com>
(T) 724-746-3304
(F) 724-514-9494

Release 12.1
November 2009

ANSYS, Inc. is
certified to ISO
9001:2008.

Copyright and Trademark Information

© 2009 SAS IP, Inc. All rights reserved. Unauthorized use, distribution or duplication is prohibited.

ANSYS, ANSYS Workbench, Ansoft, AUTODYN, EKM, Engineering Knowledge Manager, CFX, FLUENT, HFSS and any and all ANSYS, Inc. brand, product, service and feature names, logos and slogans are registered trademarks or trademarks of ANSYS, Inc. or its subsidiaries in the United States or other countries. ICEM CFD is a trademark used by ANSYS, Inc. under license. CFX is a trademark of Sony Corporation in Japan. All other brand, product, service and feature names or trademarks are the property of their respective owners.

Disclaimer Notice

THIS ANSYS SOFTWARE PRODUCT AND PROGRAM DOCUMENTATION INCLUDE TRADE SECRETS AND ARE CONFIDENTIAL AND PROPRIETARY PRODUCTS OF ANSYS, INC., ITS SUBSIDIARIES, OR LICENSORS. The software products and documentation are furnished by ANSYS, Inc., its subsidiaries, or affiliates under a software license agreement that contains provisions concerning non-disclosure, copying, length and nature of use, compliance with exporting laws, warranties, disclaimers, limitations of liability, and remedies, and other provisions. The software products and documentation may be used, disclosed, transferred, or copied only in accordance with the terms and conditions of that software license agreement.

ANSYS, Inc. is certified to ISO 9001:2008.

U.S. Government Rights

For U.S. Government users, except as specifically granted by the ANSYS, Inc. software license agreement, the use, duplication, or disclosure by the United States Government is subject to restrictions stated in the ANSYS, Inc. software license agreement and FAR 12.212 (for non-DOD licenses).

Third-Party Software

See the [legal information](#) in the product help files for the complete Legal Notice for ANSYS proprietary software and third-party software. If you are unable to access the Legal Notice, please contact ANSYS, Inc.

Published in the U.S.A.

Table of Contents

Welcome to the ANSYS Tutorials	ix
1. Start Here	1
1.1. About These Tutorials	1
1.1.1. Preparing Your Screen	1
1.1.2. Formats and Conventions Used	2
1.1.2.1. Task Steps	2
1.1.2.2. Action Substeps	3
1.1.2.3. Picking Graphics	3
1.1.2.4. Interim Result Graphics	4
1.1.3. Jobnames and Preferences	4
1.1.4. Choosing a Tutorial	4
1.2. Glossary	5
2. Structural Tutorial	9
2.1. Static Analysis of a Corner Bracket	9
2.1.1. Problem Specification	9
2.1.2. Problem Description	9
2.1.2.1. Given	10
2.1.2.2. Approach and Assumptions	10
2.1.2.3. Summary of Steps	10
2.1.3. Build Geometry	11
2.1.3.1. Step 1: Define rectangles.	12
2.1.3.2. Step 2: Change plot controls and replot.	12
2.1.3.3. Step 3: Change working plane to polar and create first circle.	13
2.1.3.4. Step 4: Move working plane and create second circle.	15
2.1.3.5. Step 5: Add areas.	16
2.1.3.6. Step 6: Create line fillet.	16
2.1.3.7. Step 7: Create fillet area.	17
2.1.3.8. Step 8: Add areas together.	18
2.1.3.9. Step 9: Create first pin hole.	18
2.1.3.10. Step 10: Move working plane and create second pin hole.	18
2.1.3.11. Step 11: Subtract pin holes from bracket.	19
2.1.3.12. Step 12: Save the database as model.db.	19
2.1.4. Define Materials	20
2.1.4.1. Step 13: Set preferences.	20
2.1.4.2. Step 14: Define material properties.	20
2.1.4.3. Step 15: Define element types and options.	21
2.1.4.4. Step 16: Define real constants.	21
2.1.5. Generate Mesh	22
2.1.5.1. Step 17: Mesh the area.	22
2.1.5.2. Step 18: Save the database as mesh.db.	23
2.1.6. Apply Loads	23
2.1.6.1. Step 19: Apply displacement constraints.	23
2.1.6.2. Step 20: Apply pressure load.	24
2.1.7. Obtain Solution	25
2.1.7.1. Step 21: Solve.	25
2.1.8. Review Results	25
2.1.8.1. Step 22: Enter the general postprocessor and read in the results.	25
2.1.8.2. Step 23: Plot the deformed shape.	25
2.1.8.3. Step 24: Plot the von Mises equivalent stress.	26
2.1.8.4. Step 25: List reaction solution.	27

2.1.8.5. Step 26: Exit the ANSYS program.	27
3. Thermal Tutorial	29
3.1. Solidification of a Casting	29
3.1.1. Problem Specification	29
3.1.2. Problem Description	29
3.1.2.1. Given	30
3.1.2.2. Approach and Assumptions	30
3.1.2.3. Summary of Steps	31
3.1.3. Prepare for a Thermal Analysis	32
3.1.3.1. Step 1: Set preferences.	32
3.1.4. Input Geometry	32
3.1.4.1. Step 2: Read in the geometry of the casting.	32
3.1.5. Define Materials	33
3.1.5.1. Step 3: Define material properties.	33
3.1.5.2. Step 4: Plot material properties vs. temperature.	34
3.1.5.3. Step 5: Define element type.	35
3.1.6. Generate Mesh	35
3.1.6.1. Step 6: Mesh the model.	35
3.1.7. Apply Loads	37
3.1.7.1. Step 7: Apply convection loads on the exposed boundary lines.	37
3.1.8. Obtain Solution	37
3.1.8.1. Step 8: Define analysis type.	37
3.1.8.2. Step 9: Examine solution control.	37
3.1.8.3. Step 10: Specify initial conditions for the transient.	38
3.1.8.4. Step 11: Set time, time step size, and related parameters.	39
3.1.8.5. Step 12: Set output controls.	40
3.1.8.6. Step 13: Solve.	40
3.1.9. Review Results	40
3.1.9.1. Step 14: Enter the time-history postprocessor and define variables.	40
3.1.9.2. Step 15: Plot temperature vs. time.	41
3.1.9.3. Step 16: Set up to animate the results.	41
3.1.9.4. Step 17: Animate the results.	42
3.1.9.5. Step 18: Exit the ANSYS program.	43
4. Electromagnetics Tutorial	45
4.1. Magnetic Analysis of a Solenoid Actuator	45
4.1.1. Problem Specification	45
4.1.2. Problem Description	45
4.1.2.1. Given	46
4.1.2.2. Approach and Assumptions	46
4.1.2.3. Summary of Steps	46
4.1.3. Input Geometry	47
4.1.3.1. Step 1: Read in geometry input file.	47
4.1.4. Define Materials	48
4.1.4.1. Step 2: Set preferences.	48
4.1.4.2. Step 3: Specify material properties.	48
4.1.5. Generate Mesh	49
4.1.5.1. Step 4: Define element types and options.	49
4.1.5.2. Step 5: Assign material properties.	49
4.1.5.3. Step 6: Specify meshing-size controls on air gap.	50
4.1.5.4. Step 7: Mesh the model using the MeshTool.	51
4.1.5.5. Step 8: Scale model to meters for solution.	51
4.1.6. Apply Loads	51

4.1.6.1. Step 9: Define the armature as a component	51
4.1.6.2. Step 10: Apply force boundary conditions to armature	52
4.1.6.3. Step 11: Apply the current density	52
4.1.6.4. Step 12: Obtain a flux parallel field solution	53
4.1.7. Obtain Solution	53
4.1.7.1. Step 13: Solve	53
4.1.8. Review Results	53
4.1.8.1. Step 14: Plot the flux lines in the model	53
4.1.8.2. Step 15: Summarize magnetic forces	54
4.1.8.3. Step 16: Plot the flux density as vectors	54
4.1.8.4. Step 17: Plot the magnitude of the flux density	54
4.1.8.5. Step 18: Exit the ANSYS program	55
5. Micro-Electromechanical System (MEMS) Tutorial	57
5.1. Multiphysics Analysis of a Thermal Actuator	57
5.1.1. Problem Specification	57
5.1.2. Problem Description	57
5.1.2.1. Given	58
5.1.2.2. Approach and Assumptions	59
5.1.2.3. Summary of Steps	59
5.1.3. Import Geometry	60
5.1.3.1. Step 1: Import IGES file	60
5.1.4. Define Materials	61
5.1.4.1. Step 2: Define element type	61
5.1.4.2. Step 3: Define material properties	61
5.1.5. Generate Mesh	62
5.1.5.1. Step 4: Mesh the model	62
5.1.6. Apply Loads	62
5.1.6.1. Step 5: Plot areas	62
5.1.6.2. Step 6: Apply boundary conditions to electrical connection pad 1	62
5.1.6.3. Step 7: Apply boundary conditions to electrical connection pad 2	64
5.1.7. Obtain Solution	66
5.1.7.1. Step 8: Solve	66
5.1.8. Review Results	66
5.1.8.1. Step 9: Plot temperature results	66
5.1.8.2. Step 10: Plot voltage results	66
5.1.8.3. Step 11: Plot displacement results and animate	67
5.1.8.4. Step 12: List total heat flow and current	68
5.1.8.5. Step 13: Exit the ANSYS program	68
6. Explicit Dynamics Tutorial	71
6.1. Drop Test of a Container (Explicit Dynamics)	71
6.1.1. Problem Specification	71
6.1.2. Problem Description	71
6.1.2.1. Given	72
6.1.2.2. Approach and Assumptions	72
6.1.2.3. Summary of Steps	72
6.1.3. Define Analysis Type	73
6.1.3.1. Step 1: Set Preferences	73
6.1.4. Input Geometry	73
6.1.4.1. Step 2: Read in geometry of the container	73
6.1.5. Define Element Type, Real Constants, Material Model Properties	74
6.1.5.1. Step 3: Define element type	74
6.1.5.2. Step 4: Define real constants	74

6.1.5.3. Step 5: Specify material models.	75
6.1.6. Generate Mesh	75
6.1.6.1. Step 6: Mesh the container.	75
6.1.6.2. Step 7: Generate table top elements.	76
6.1.6.3. Step 8: Create container component.	77
6.1.6.4. Step 9: Create table top component.	78
6.1.6.5. Step 10: Specify contact parameters.	78
6.1.7. Apply Loads	79
6.1.7.1. Step 11: Apply initial velocity to the container.	79
6.1.7.2. Step 12: Apply acceleration to the container.	79
6.1.8. Obtain Solution	80
6.1.8.1. Step 13: Specify output controls.	80
6.1.8.2. Step 14: Solve.	80
6.1.9. Review Results	81
6.1.9.1. Step 15: Animate stress contours.	81
6.1.9.2. Step 16: Animate deformed shape.	81
6.1.9.3. Step 17: Exit the ANSYS program.	82
7. Contact Tutorial	83
7.1. Interference Fit and Pin Pull-Out Contact Analysis	83
7.1.1. Problem Specification	83
7.1.2. Problem Description	84
7.1.2.1. Given	84
7.1.2.2. Approach and Assumptions	84
7.1.2.3. Summary of Steps	84
7.1.3. Input Geometry	86
7.1.3.1. Step 1: Read in the model of the pin and block.	86
7.1.4. Define Material Property and Element Type	86
7.1.4.1. Step 2: Define material.	86
7.1.4.2. Step 3: Define element types.	86
7.1.5. Generate Mesh	87
7.1.5.1. Step 4: Mesh solid volume.	87
7.1.5.2. Step 5: Smooth element edges for graphics display.	88
7.1.5.3. Step 6: Create contact pair using Contact Wizard.	88
7.1.6. Specify Solution Criteria	89
7.1.6.1. Step 7: Apply symmetry constraints on (quartered) volume.	89
7.1.6.2. Step 8: Define boundary constraints on block.	89
7.1.6.3. Step 9: Specify a large displacement static analysis.	90
7.1.7. Load Step 1	90
7.1.7.1. Step 10: Define interference fit analysis options.	90
7.1.7.2. Step 11: Solve load step 1.	90
7.1.8. Load Step 2	91
7.1.8.1. Step 12: Set DOF displacement for pin.	91
7.1.8.2. Step 13: Define pull-out analysis options.	91
7.1.8.3. Step 14: Write results to file.	91
7.1.8.4. Step 15: Solve load step 2.	92
7.1.9. Postprocessing	92
7.1.9.1. Step 16: Expand model from quarter symmetry to full volume.	92
7.1.9.2. Step 17: Observe interference fit stress state.	93
7.1.9.3. Step 18: Observe intermediate contact pressure on pin.	93
7.1.9.4. Step 19: Observe pulled-out stress state.	94
7.1.9.5. Step 20: Animate pin pull-out.	94
7.1.9.6. Step 21: Plot reaction forces for pin pull-out.	94

7.1.9.7. Step 22: Exit the ANSYS program.	95
8. Modal Tutorial	97
8.1. Modal Analysis of a Model Airplane Wing	97
8.1.1. Problem Specification	97
8.1.2. Problem Description	97
8.1.2.1. Given	98
8.1.2.2. Approach and Assumptions	98
8.1.2.3. Summary of Steps	98
8.1.3. Input Geometry	99
8.1.3.1. Step 1: Read in geometry input file.	99
8.1.4. Define Materials	99
8.1.4.1. Step 2: Set preferences.	99
8.1.4.2. Step 3: Define constant material properties.	99
8.1.5. Generate Mesh	100
8.1.5.1. Step 4: Define element types.	100
8.1.5.2. Step 5: Mesh the area.	100
8.1.5.3. Step 6: Extrude the meshed area into a meshed volume.	101
8.1.6. Apply Loads	102
8.1.6.1. Step 7: Unselect 2-D elements.	102
8.1.6.2. Step 8: Apply constraints to the model.	102
8.1.7. Obtain Solution	103
8.1.7.1. Step 9: Specify analysis type and options.	103
8.1.7.2. Step 10: Solve.	103
8.1.8. Review Results	103
8.1.8.1. Step 11: List the natural frequencies.	103
8.1.8.2. Step 12: Animate the five mode shapes.	103
8.1.8.3. Step 13: Exit the ANSYS program.	105
9. Probabilistic Design System (PDS) Tutorial	107
9.1. Probabilistic Design of a Simple Plate with a Single Force Load	107
9.1.1. Problem Specification	107
9.1.2. Problem Description	107
9.1.2.1. Given	108
9.1.2.2. Approach and Assumptions	109
9.1.2.3. Summary of Steps	109
9.1.3. Specify Analysis File	110
9.1.3.1. Step 1: Enter PDS and specify analysis file.	110
9.1.4. Define Input and Output	110
9.1.4.1. Step 2: Define input variables.	110
9.1.4.2. Step 3: Define output parameters.	112
9.1.5. Obtain Solution	112
9.1.5.1. Step 4: Execute Monte Carlo simulations.	112
9.1.6. Perform Postprocessing	113
9.1.6.1. Step 5: Perform statistical postprocessing.	113
9.1.6.2. Step 6: Perform trend postprocessing.	115
9.1.7. Generate Report	117
9.1.7.1. Step 7: Generate HTML report and exit.	117
10. ANIMATE Program	119

Welcome to the ANSYS Tutorials

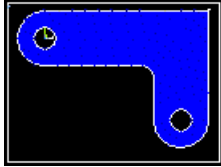

The ANSYS Tutorials provide an introduction to the extensive capabilities of the ANSYS family of products. Each tutorial is a complete step-by-step ANSYS analysis procedure. You can choose from several analysis disciplines. The tutorials are designed to be run interactively, on the same screen as the ANSYS program. Included are full color ANSYS graphics and animations that are exact replicas of what appear at several points within the steps of the tutorials. A glossary of terms is also included that you can view as a stand-alone document with an alphabetical listing of the terms, or you can view the definition of terms on demand by simply clicking on linked terms within the context of the tutorials.

Before you begin a tutorial, read the [Start Here](#) section for recommendations on preparing your screen for displaying the tutorial window on the same screen as ANSYS, as well as descriptions of the formats and conventions used in the tutorials.

Chapter 1: Start Here

- [About These Tutorials](#)
- [Preparing Your Screen](#)
- [Formats and Conventions Used](#)
- [Jobnames and Preferences](#)
- [Choosing a Tutorial](#)

1.1. About These Tutorials

The purpose of these tutorials is to introduce you to the extensive capabilities of the ANSYS family of products -- recognized worldwide as the most powerful engineering design and analysis software. This introduction is done through tutorials that are designed to be run interactively, *online* at your computer terminal.

1.1.1. Preparing Your Screen

Running the tutorials online *while* running ANSYS requires that you make the best use of your screen's real estate. By making minor adjustments to the dimensions of the browser and the ANSYS GUI, you will be able to read a tutorial's instructions on one side of your screen, and perform the instructions in ANSYS on the other side. Presented below is a sample screen layout captured on a 21 inch monitor. It is a typical representation of how a screen looks while running a tutorial using the PC version of ANSYS.

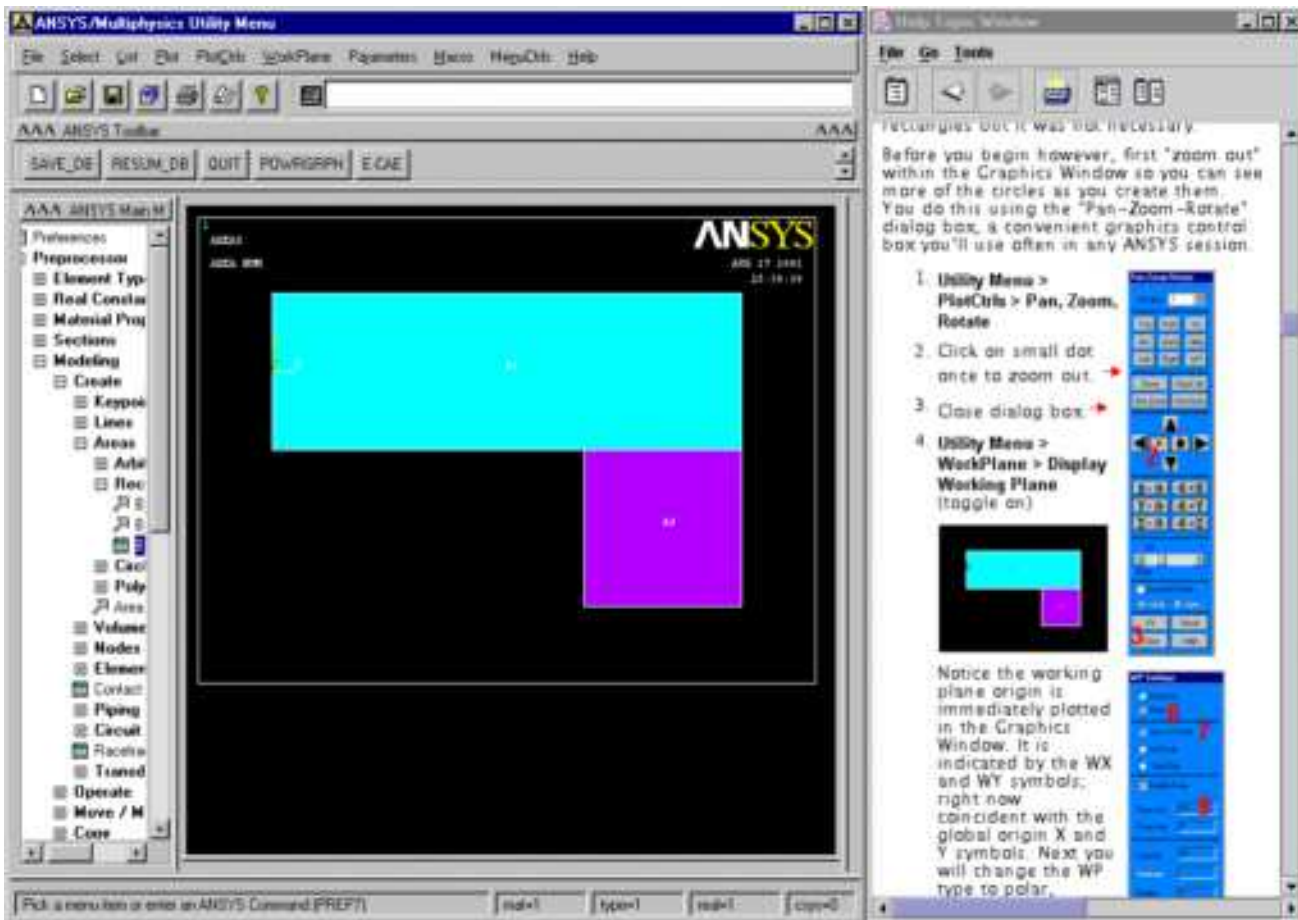

For this layout, the tutorial window containing the tabs was removed by clicking the **Undock** button (large button located furthest to the right), then minimizing the tabbed window. The tutorial window was then moved to the right side of the screen and the ANSYS window was reduced horizontally to accommodate the tutorial window. You should use this layout as a model to adjust your screen accordingly, based on the size of your monitor. It is assumed that you are proficient in *moving* ANSYS dialog boxes because there are times when they "pop up" on top of either the tutorial or the ANSYS window. If this occurs, you can simply move them anywhere on the screen by dragging the window header.

1.1.2. Formats and Conventions Used

Each tutorial begins with a problem description that includes approaches and assumptions. A summary of steps in the form of tasks is then presented with each step being a hyperlink to a detailed series of procedural action substeps for each major task step. The analysis action substeps are shown explicitly in terms of menu choices, graphical picks, and text input.

1.1.2.1. Task Steps

Task steps are numbered sequentially and contain a series of related menu paths and action substeps. Step titles are formatted according to the task you will be performing in the step. Example step titles are "Add areas," "Define material properties," "Mesh the area," and "Plot the deformed shape." There are approximately 20 steps in a tutorial with the number varying depending on the complexity of the tutorial.

1.1.2.2. Action Substeps

For each overall task step, there are any number of substeps that guide you through the actions that you need to perform in order to accomplish the task step. A menu path is typically one of the first substeps within a task step. An example of a menu path substep is:

1. **Main Menu> Preprocessor> Modeling> Operate> Booleans> Add> Areas**

A menu path represents the complete location of a particular function in the Graphical User Interface (GUI). The first part of the path (Main Menu) determines where the function is found. It is usually either the Main Menu or the Utility Menu. Go to that region to perform the function. The remaining part of the path lists the menu topics that you click with the left mouse button.

The action substeps that are presented after a menu path either guide you through completing a dialog box, or instruct you graphically on picking locations. The graphical picking convention is described in the next section.

For completing a dialog box, the substeps are either spelled out in detail or use a condensed procedure format. Detailed substeps are followed by a red arrow (➔) indicating that a small picture of the dialog box is available if you scroll to the right. The picture includes large red numbers that cross-reference the numbers of the action. The numbers are positioned in the dialog box at the locations where you are to perform the actions (button, box, drop-down list, etc.). Substeps in several of the tutorials use a condensed procedure format that uses the following conventions:

- Items that you need to fill in reproduce the wording in the dialog boxes and are in quotes, followed by an equal sign, then the value you should enter. Example:
 3. "Load VOLT Value" = 5
- Button labels are in brackets. Example:
 4. [Pick All]
- Actions, locations, or any other items that may not be obvious are enclosed in parentheses before or after GUI wording in quotes. Examples:
 - 2. (double-click) "Structural"
 - 5. (drop down) "Action"
 - 7. "Scaler Tet 98" (right column)

1.1.2.3. Picking Graphics

Some substeps instruct you to pick specific entities on a graphic. An example of the convention is shown below:

6. Pick lines 17 and 8

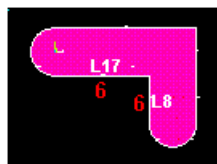

Here, red numbers are displayed on the picture at the locations where you are to pick. The red number is a cross reference to the procedural substep.

1.1.2.4. Interim Result Graphics

Following the substeps, a task step typically concludes with a small interim result graphic that shows how the ANSYS graphic should appear in the Graphics window at a particular point in a tutorial. An example is shown below:

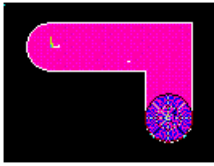

1.1.3. Jobnames and Preferences

Though not required, it is good practice for you to specify a particular [jobname](#) for each tutorial analysis. This will help you identify files generated by ANSYS that are related to a particular analysis. When starting ANSYS, you can specify the jobname in the launcher. While in ANSYS, you can change the jobname by choosing:

Utility Menu > File > Change Jobname

then typing the jobname, and choosing OK.

It is also good practice to specify [preferences](#) for each tutorial analysis. When you specify a preference for a particular engineering discipline, ANSYS filters menu choices such that the only choices that appear apply to the discipline you specified. If you do not specify preferences, menu choices for all disciplines are shown, but non-applicable choices are dimmed based on the set of element types in the model. It is a good idea to specify preferences at or near the beginning of an analysis. Most of the tutorials have this step built in before the model is meshed. You can specify a preference by choosing:

Main Menu > Preferences

then checking the box associated with the particular discipline, and choosing OK.

1.1.4. Choosing a Tutorial

We recommend that you run [Chapter 2, Structural Tutorial \(p. 9\)](#) first, even if you typically run analyses in other engineering disciplines. The Structural tutorial is documented extensively, includes graphics of all dialog boxes used, and introduces you to ANSYS terms that you'll see in other tutorials. Once you have successfully performed this tutorial, you can run any of the others in any order. You may want to choose a problem that demonstrates the ANSYS features in your discipline. However, all of the tutorials in some way demonstrate ANSYS techniques that are universal for ANSYS users. You can learn something from every problem, even if it is not in your particular field of interest or experience!

You can access a tutorial through the main Table Of Contents or by clicking on the name of the tutorial in the following list:

- [Chapter 2, Structural Tutorial \(p. 9\)](#)
- [Chapter 3, Thermal Tutorial \(p. 29\)](#)
- [Chapter 4, Electromagnetics Tutorial \(p. 45\)](#)
- [Chapter 5, Micro-Electromechanical System \(MEMS\) Tutorial \(p. 57\)](#)
- [Chapter 6, Explicit Dynamics Tutorial \(p. 71\)](#)

- [Chapter 7, Contact Tutorial](#) (p. 83)
- [Chapter 8, Modal Tutorial](#) (p. 97)
- [Chapter 9, Probabilistic Design System \(PDS\) Tutorial](#) (p. 107)
- [Chapter 10, ANIMATE Program](#) (p. 119)

1.2. Glossary

ANSYS ED Program	An educational program that can be used as a personal training tool in industry, at universities and other academic institutions, and at home. The ANSYS ED program is similar to ANSYS Multiphysics in that it contains virtually all of the features of ANSYS Multiphysics and uses the same GUI, but it contains limits for the size of the model that can be created and solved.
ANSYS Features Demonstrated	Lists the noteworthy features demonstrated in the problem.
Analysis Options	Typical analysis options are the method of solution, stress stiffening on or off, and Newton-Raphson options for nonlinearities.
Analysis Type	Any of seven analysis types offered in ANSYS: static, modal, harmonic, transient, spectrum, eigenvalue buckling, and substructuring. Whether the problem is linear or nonlinear will be identified here.
Applicable ANSYS Products	Indicates which ANSYS programs can be used to run the example problem. Applicable products are determined by the discipline and complexity of the problem. Possibilities include: ANSYS Multiphysics, ANSYS Mechanical, ANSYS Professional, ANSYS Structural, ANSYS LS-DYNA, ANSYS Emag, ANSYS FLOTRAN, ANSYS PrepPost, ANSYS ED .
Applicable Help Available	Information in the ANSYS help system that is relevant to the overall topics covered in a particular tutorial.
Boolean Operations	Boolean Operations (based on Boolean algebra) provide a means of combining sets of data using such logical operators as add, subtract, intersect, etc. There are Boolean operations available for volume, area, and line solid model entities.
Direct Element Generation	Defining an element by defining nodes directly.
Discipline	Any of five physical (engineering) disciplines may be solved by the ANSYS program: structural, thermal, electric, magnetic, and fluid. Note that you can use the ANSYS Multi-field solver, which considers the effects of the physical phenomena coupled together, such as temperature and displacement in a thermal-stress analysis.
Element Options	Many element types also have additional element options to specify such things as element behavior and assumptions, element results printout options, etc.
Element Types Used	Indicates the element types used in the problem; over 100 element types are available in ANSYS. You choose an element type which characterizes, among other things, the degree-of-freedom set (displacements and/or rotations, temperatures, etc.) the characteristic shape of the element (line, quadrilateral,

brick, etc.), whether the element lies in 2-D space or 3-D space, the response of your system, and the accuracy level you're interested in.

Gaussian Distribution

The Gaussian or normal distribution is a very fundamental and commonly used distribution for statistical matters. It is typically used to describe the scatter of the measurement data of many physical phenomena. Strictly speaking, every random variable follows a normal distribution if it is generated by a linear combination of a very large number of other random effects, regardless which distribution these random effects originally follow. The Gaussian distribution is also valid if the random variable is a linear combination of two or more other effects if those effects also follow a Gaussian distribution.

You provide values for the mean value μ and the standard deviation σ of the random variable x .

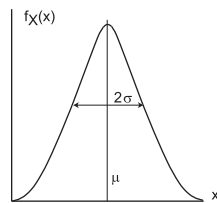

Higher-Order Elements

Higher-order, or midside-node elements, have a quadratic shape function (instead of linear) to map degree-of-freedom values within the element.

Interactive Time Required

This is an approximate range, in minutes, for you to complete the interactive step-by-step solution. Of course the amount of time it takes you to perform the problem depends on the computer system you use, the amount of network "traffic" on it, the working pace that is comfortable for you, and so on.

Jobname

The file name prefix used for all files generated in an ANSYS analysis. All files are named *Jobname.ext*, where *ext* is a unique ANSYS extension that identifies the contents of the file. The jobname specified in the launcher when you start ANSYS is called the *initial* jobname. You can always change the jobname within an ANSYS session.

Latin Hypercube Sampling

The Latin Hypercube Sampling (LHS) technique is a Monte Carlo Simulation method that is more advanced and efficient than the Direct Monte Carlo Sampling technique. LHS has a sample "memory," meaning it avoids repeating samples that have been evaluated before (it avoids clustering samples). It also forces the tails of a distribution to participate in the sampling process.

Level of Difficulty

Three levels are offered: easy, moderate, and advanced. Although the "advanced" problems are still easy to follow using the interactive step-by-step solution, they include features that are typically thought of as advanced ANSYS capabilities, such as nonlinearities, macros, or advanced postprocessing.

Lognormal Distribution

The lognormal distribution is a basic and commonly used distribution. It is typically used to describe the scatter of the measurement data of physical phenomena, where the logarithm of the data would follow a normal distribution. The lognormal distribution is very suitable for phenomena that arise from the multiplication of a large number of error effects. It is also correct to use the lognormal distribution for a random variable that is the result of

	multiplying two or more random effects (if the effects that get multiplied are also lognormally distributed).
Material Properties	Physical properties of a material such as modulus of elasticity or density that are independent of geometry. Although they are not necessarily tied to the element type, the material properties required to solve the element matrices are listed for each element type for your convenience. Depending on the application, material properties may be linear, nonlinear, and/or anisotropic. As with element types and real constants, you may have multiple material property sets (to correspond with multiple materials) within one analysis. Each set is given a reference number.
Monte Carlo	The Monte Carlo Simulation method is the most common and traditional method for a probabilistic analysis. This method lets you simulate how virtual components behave the way they are built. One simulation loop represents one manufactured component that is subjected to a particular set of loads and boundary conditions.
Plane Stress	A state of stress in which the normal stress and the shear stresses directed perpendicular to the plane are assumed to be zero.
Postprocessing	ANSYS analysis phase where you review the results of the analysis through graphics displays and tabular listings. The general postprocessor (POST1) is used to review results at one substep (time step) over the entire model. The time-history postprocessor (POST26) is used to review results at specific points in the model over all time steps.
Preferences	The "Preferences" dialog box allows you to choose the desired engineering discipline for context filtering of menu choices. By default, menu choices for all disciplines are shown, with non-applicable choices "dimmed" based on a set of element types in your model. If you prefer not to see the dimmed choices at all, you should turn on filtering. For example, turning on structural filtering completely suppresses all thermal, electromagnetic, and fluid menu topics.
Preprocessing	ANSYS analysis phase where you provide data such as the geometry, materials, and element types to the program.
Primitives	Simple predefined geometric shapes that ANSYS provides. A rectangle primitive, for example defines the following solid model entities in one step: one area, four lines, and four keypoints.
Probabilistic Analysis File	A probabilistic analysis file is an ANSYS input file that contains a complete analysis sequence (preprocessing, solution, postprocessing). It must contain a parametrically defined model using parameters to represent all inputs and outputs which will be used as random input variables (RVs) and random output parameters (RPs). From this file, a probabilistic design loop file (Job-name.LOOP) is automatically created and used by the probabilistic design system to perform analysis loops.
Probabilistic Design	Probabilistic Design is a technique you can use to assess the effect of uncertain input parameters and assumptions on your analysis model. Using a probabilistic analysis you can find out how much the results of a finite element analysis are affected by uncertainties in the model.

Probabilistic Simulation	A simulation is the collection of all samples that are required or that you request for a certain probabilistic analysis. A simulation contains the information used to determine how the component would behave under real-life conditions (with all the existing uncertainties and scatter), and all samples therefore represent the simulation of this behavior.
Random Input Variables	Random Input Variables (RVs) are quantities that influence the result of an analysis. In probabilistic literature, these random input variables are also called the "drivers" because they drive the result of an analysis.
Random Output Parameters	Random Output Parameters (RPs) are the results of a finite element analysis. The RPs are typically a function of the random input variables (RVs); that is, changing the values of the random input variables should change the value of the random output parameters.
Real Constants	Provide additional geometry information for element types whose geometry is not fully defined by its node locations. Typical real constants include shell thicknesses for shell elements and cross-sectional properties for beam elements. All properties required as input for a particular element type are entered as one <i>set</i> of real constants.
Solution	ANSYS analysis phase where you define analysis type and options, apply loads and load options, and initiate the finite element solution. A new, static analysis is the default.
Standard Deviation	The standard deviation is a measure of variability (dispersion or spread) about the arithmetic mean value; this is often used to describe the width of the scatter of a random output parameter or of a statistical distribution function. The larger the standard deviation the wider the scatter and the more likely it is that there are data values further apart from the mean value.
Uniform Distribution	The uniform distribution is a very fundamental distribution for cases where no other information apart from a lower and an upper limit exists. It is very useful to describe geometric tolerances. It can also be used in cases where there is no evidence that any value of the random variable is more likely than any other within a certain interval.

You provide the lower and the upper limit x_{min} and x_{max} of the random variable x .

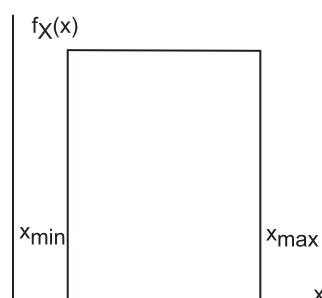

Working Plane (WP)	An imaginary plane with an origin, a 2-D coordinate system (either Cartesian or Polar), a snap increment, and a display grid. It is used to locate solid model entities. By default, the working plane is a Cartesian plane located at the global origin.
--------------------	---

Chapter 2: Structural Tutorial

Static Analysis of a Corner Bracket



- Problem Specification
- Problem Description
- Build Geometry
- Define Materials
- Generate Mesh
- Apply Loads
- Obtain Solution
- Review Results

2.1. Static Analysis of a Corner Bracket

2.1.1. Problem Specification

Applicable ANSYS Products:	ANSYS Multiphysics, ANSYS Mechanical, ANSYS Structural, ANSYS ED
Level of Difficulty:	easy
Interactive Time Required:	60 to 90 minutes
Discipline:	structural
Analysis Type:	linear static
Element Types Used:	PLANE82
ANSYS Features Demonstrated:	solid modeling including primitives, Boolean operations, and fillets; tapered pressure load; deformed shape and stress displays; listing of reaction forces; examination of structural energy error
Applicable Help Available:	Structural Static Analysis in the <i>Structural Analysis Guide</i> , PLANE82 in the <i>Element Reference</i> .

2.1.2. Problem Description

This is a simple, single load step, structural static analysis of the corner angle bracket shown below. The upper left-hand pin hole is constrained (welded) around its entire circumference, and a tapered pressure

load is applied to the bottom of the lower right-hand pin hole. The objective of the problem is to demonstrate the typical ANSYS analysis procedure. The US Customary system of units is used.

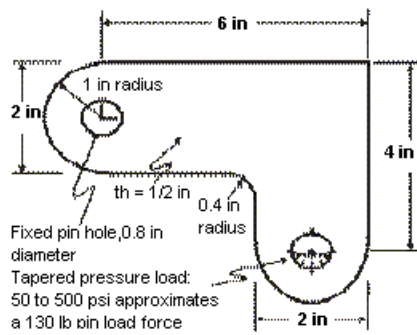

2.1.2.1. Given

The dimensions of the corner bracket are shown in the accompanying figure. The bracket is made of A36 steel with a Young's modulus of $30E6$ psi and Poisson's ratio of .27.

2.1.2.2. Approach and Assumptions

Assume **plane stress** for this analysis. Since the bracket is thin in the z direction (1/2 inch thickness) compared to its x and y dimensions, and since the pressure load acts only in the x - y plane, this is a valid assumption.

Your approach is to use solid modeling to generate the 2-D model and automatically mesh it with nodes and elements. (Another alternative in ANSYS is to create the nodes and elements directly.)

2.1.2.3. Summary of Steps

Use the information in the problem description and the steps below as a guideline in solving the problem on your own. Or, use the detailed interactive step-by-step solution by choosing the link for step 1.

Note

If your system includes a Flash player (from Macromedia, Inc.), you can view demonstration videos of each step by pointing your web browser to the following URL address: http://www.ansys.com/techmedia/structural_tutorial_videos.html.

Build Geometry

1. Define rectangles.
2. Change plot controls and replot.
3. Change working plane to polar and create first circle.
4. Move working plane and create second circle.
5. Add areas.
6. Create line fillet.
7. Create fillet area.

8. Add areas together.
9. Create first pin hole.
10. Move working plane and create second pin hole.
11. Subtract pin holes from bracket.
12. Save the database as model.db.

Define Materials

13. Set Preferences.
14. Define Material Properties.
15. Define element types and options.
16. Define real constants.

Generate Mesh

17. Mesh the area.
18. Save the database as mesh.db.

Apply Loads

19. Apply displacement constraints.
20. Apply pressure load.

Obtain Solution

21. Solve.

Review Results

22. Enter the general postprocessor and read in the results.
23. Plot the deformed shape.
24. Plot the von Mises equivalent stress.
25. List the reaction solution.
26. Exit the ANSYS program.

2.1.3. Build Geometry

This is the beginning of Preprocessing.

2.1.3.1. Step 1: Define rectangles.

There are several ways to create the model geometry within ANSYS, some more convenient than others. The first step is to recognize that you can construct the bracket easily with combinations of rectangles and circle Primitives.

Decide where the origin will be located and then define the rectangle and circle primitives relative to that origin. The location of the origin is arbitrary. Here, use the center of the upper left-hand hole. ANSYS does not need to know where the origin is. Simply begin by defining a rectangle relative to that location. In ANSYS, this origin is called the **global origin**.

1. **Main Menu> Preprocessor> Modeling> Create> Areas> Rectangle> By Dimensions**

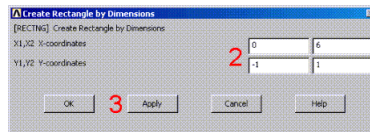

2. Enter the following:

$X1 = 0$ (Note: Press the Tab key between entries)

$X2 = 6$

$Y1 = -1$

$Y2 = 1$ →

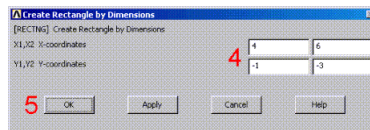

3. Apply to create the first rectangle. →

4. Enter the following:

$X1 = 4$

$X2 = 6$

$Y1 = -1$

$Y2 = -3$ →

5. OK to create the second rectangle and close the dialog box. →

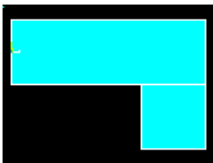

2.1.3.2. Step 2: Change plot controls and replot.

The area plot shows both rectangles, which are *areas*, in the same color. To more clearly distinguish between areas, turn on area numbers and colors. The "Plot Numbering Controls" dialog box on the Utility Menu controls how items are displayed in the Graphics Window. By default, a "replot" is automatically performed

upon execution of the dialog box. The replot operation will repeat the last plotting operation that occurred (in this case, an area plot).

1. **Utility Menu> PlotCtrls> Numbering**
2. Turn on area numbers. →
3. OK to change controls, close the dialog box, and replot.

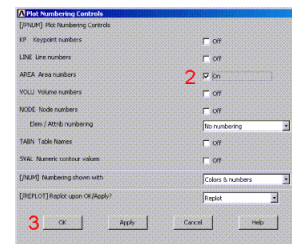
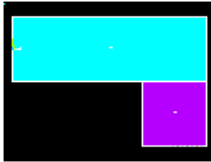

Before going to the next step, save the work you have done so far. ANSYS stores any input data in memory to the **ANSYS database**. To save that database to a file, use the SAVE operation, available as a tool on the Toolbar. ANSYS names the database file using the format *jobname.db*. If you started ANSYS using the product launcher, you can specify a *jobname* at that point (the default jobname is *file*). You can check the current jobname at any time by choosing **Utility Menu> List> Status> Global Status**. You can also save the database at specific milestone points in the analysis (such as after the model is complete, or after the model is meshed) by choosing **Utility Menu> File> Save As** and specifying different jobnames (*model.db*, or *mesh.db*, etc.).

It is important to do an occasional save so that if you make a mistake, you can restore the model from the last saved state. You restore the model using the RESUME operation, also available on the Toolbar. (You can also find SAVE and RESUME on the Utility Menu, under File.)

4. Toolbar: **SAVE_DB**.

2.1.3.3. Step 3: Change working plane to polar and create first circle.

The next step in the model construction is to create the half circle at each end of the bracket. You will actually create a full circle on each end and then combine the circles and rectangles with a Boolean "add" operation (discussed in step 5.). To create the circles, you will use and display the **working plane**. You could have shown the working plane as you created the rectangles but it was not necessary.

Before you begin however, first "zoom out" within the Graphics Window so you can see more of the circles as you create them. You do this using the "Pan-Zoom-Rotate" dialog box, a convenient graphics control box you'll use often in any ANSYS session.

1. **Utility Menu> PlotCtrls> Pan, Zoom, Rotate**

2. Click on small dot once to zoom out. →



3. Close dialog box. →

4. **Utility Menu> WorkPlane> Display Working Plane** (toggle on)

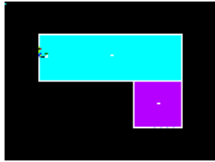

Notice the working plane origin is immediately plotted in the Graphics Window. It is indicated by the WX and WY symbols; right now coincident with the global origin X and Y symbols. Next you will change the WP type to polar, change the snap increment, and display the grid.

5. **Utility Menu> WorkPlane> WP Settings**

6. Click on Polar. →

7. Click on Grid and Triad. →

8. Enter .1 for snap increment. →

9. OK to define settings and close the dialog box. →

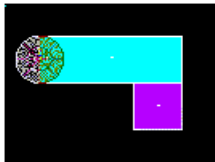

10. **Main Menu> Preprocessor> Modeling> Create> Areas> Circle> Solid Circle**

Be sure to read prompt before picking.

11. Pick center point at:

WP X = 0 (in Graphics Window shown below)

WP Y = 0

12. Move mouse to radius of 1 and click left button to create circle.

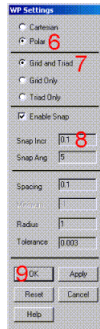
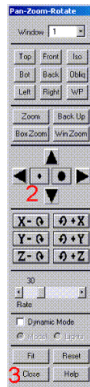

[C:\14] Pick 2 WP locations - center and radius.

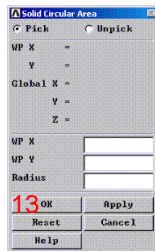

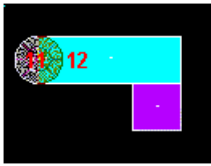

13. OK to close picking menu. →
14. Toolbar: **SAVE_DB**.

Note

While you are positioning the cursor for picking, the "dynamic" WP X and Y values are displayed in the Solid Circular Area dialog box. Also, as an alternative to picking, you can type these values along with the radius into the dialog box.

2.1.3.4. Step 4: Move working plane and create second circle.

To create the circle at the other end of the bracket in the same manner, you need to first move the working plane to the origin of the circle. The simplest way to do this without entering number offsets is to move the WP to an average keypoint location by picking the keypoints at the bottom corners of the lower, right rectangle.

1. **Utility Menu > WorkPlane > Offset WP to > Keypoints**
2. Pick keypoint at lower *left* corner of rectangle.
3. Pick keypoint at lower *right* of rectangle.

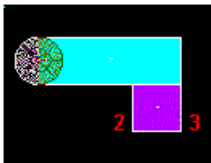

4. OK to close picking menu.

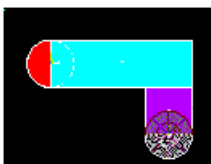

5. **Main Menu > Preprocessor > Modeling > Create > Areas > Circle > Solid Circle**
6. Pick center point at:

WP X = 0

WP Y = 0

7. Move mouse to radius of 1 and click left button to create circle.

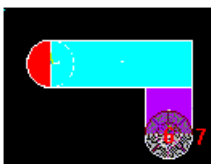

- OK to close picking menu.

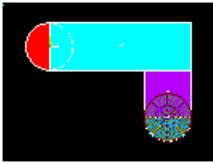

- Toolbar: **SAVE_DB**.

2.1.3.5. Step 5: Add areas.

Now that the appropriate pieces of the model are defined (rectangles and circles), you need to add them together so the model becomes one continuous piece. You do this with the **Boolean** add operation for areas.

- Main Menu > Preprocessor > Modeling > Operate > Booleans > Add > Areas**

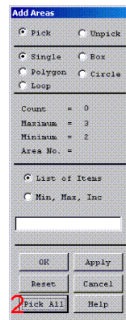

- Pick All for all areas to be added. →

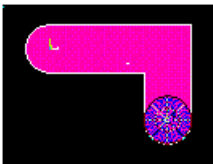

- Toolbar: **SAVE_DB**.

2.1.3.6. Step 6: Create line fillet.

- Utility Menu > PlotCtrls > Numbering**
- Turn on line numbering. →
- OK to change controls, close the dialog box, and automatically replot. →

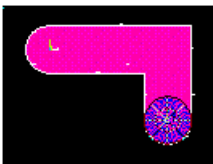
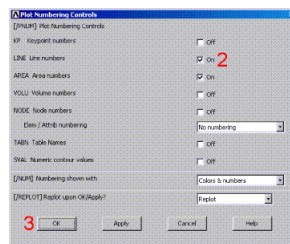

- Utility Menu > WorkPlane > Display Working Plane** (toggle off)

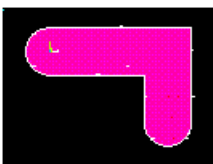
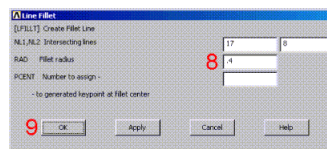

- Main Menu > Preprocessor > Modeling > Create > Lines > Line Fillet**
- Pick lines 17 and 8.

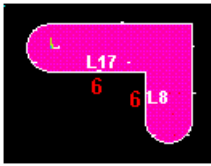

7. OK to finish picking lines (in picking menu).
8. Enter .4 as the radius. →
9. OK to create line fillet and close the dialog box. →
10. **Utility Menu> Plot> Lines**

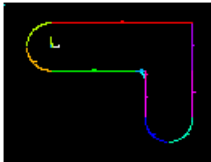

2.1.3.7. Step 7: Create fillet area.

1. **Utility Menu> PlotCtrls> Pan, Zoom, Rotate**
2. Click on Zoom button. →
3. Move mouse to fillet region, click left button, move mouse out and click again.

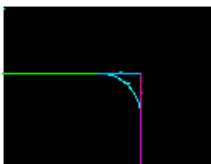
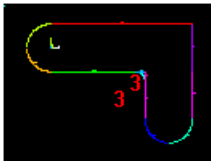

4. **Main Menu> Preprocessor> Modeling> Create> Areas> Arbitrary> By Lines**
5. Pick lines 4, 5, and 1.

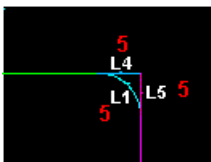

6. OK to create area and close the picking menu.

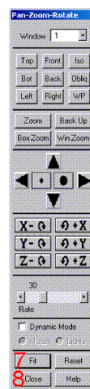
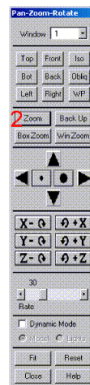

7. Click on Fit button. →
8. Close the Pan, Zoom, Rotate dialog box. →
9. **Utility Menu> Plot> Areas**

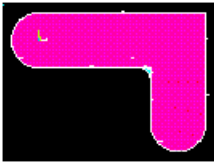

10. Toolbar: **SAVE_DB**.

2.1.3.8. Step 8: Add areas together.

1. **Main Menu> Preprocessor> Modeling> Operate> Booleans> Add> Areas**
2. Pick All for all areas to be added. →

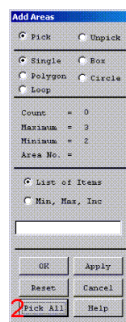

3. Toolbar: **SAVE_DB**.

2.1.3.9. Step 9: Create first pin hole.

1. **Utility Menu> WorkPlane> Display Working Plane** (toggle on)

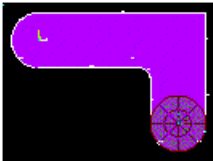

2. **Main Menu> Preprocessor> Modeling> Create> Areas> Circle> Solid Circle**
3. Pick center point at:

WP X = 0 (in Graphics Window)

WP Y = 0

4. Move mouse to radius of .4 (shown in the picking menu) and click left button to create circle.
5. OK to close picking menu.

2.1.3.10. Step 10: Move working plane and create second pin hole.

1. **Utility Menu> WorkPlane> Offset WP to> Global Origin**
2. **Main Menu> Preprocessor> Modeling> Create> Areas> Circle> Solid Circle**
3. Pick center point at:

WP X = 0 (in Graphics Window)

WP Y = 0

4. Move mouse to radius of .4 (shown in the picking menu) and click left mouse button to create circle.
5. OK to close picking menu.
6. **Utility Menu> WorkPlane> Display Working Plane** (toggle off)
7. **Utility Menu> Plot> Replot**



From this area plot, it appears that one of the pin hole areas is not there. However, it is there (as indicated by the presence of its lines), you just can't see it in the final display of the screen. That is because the bracket area is drawn on top of it. An easy way to see all areas is to plot the lines instead.

8. **Utility Menu> Plot> Lines**

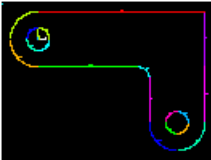

9. Toolbar: **SAVE_DB**.

2.1.3.11. Step 11: Subtract pin holes from bracket.

1. **Main Menu> Preprocessor> Modeling> Operate> Booleans> Subtract> Areas**
2. Pick bracket as base area from which to subtract.
3. Apply (in picking menu).
4. Pick both pin holes as areas to be subtracted.

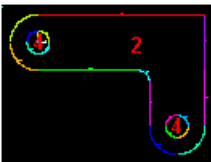

5. OK to subtract holes and close picking menu.



2.1.3.12. Step 12: Save the database as model.db.

At this point, you will save the database to a named file -- a name that represents the model before meshing. If you decide to go back and remesh, you'll need to resume this database file. You will save it as *model.db*.

1. **Utility Menu> File> Save As**
2. Enter *model.db* for the database file name. →
3. OK to save and close dialog box. →

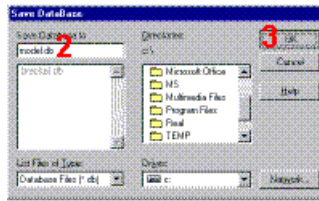

2.1.4. Define Materials

2.1.4.1. Step 13: Set preferences.

In preparation for defining materials, you will set **preferences** so that only materials that pertain to a structural analysis are available for you to choose.

To set preferences:

1. **Main Menu> Preferences**
2. Turn on structural filtering. The options may differ from what is shown here since they depend on the **ANSYS product** you are using. →
3. OK to apply filtering and close the dialog box. →

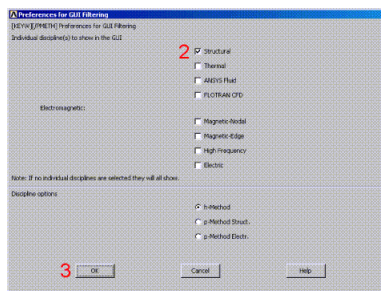

2.1.4.2. Step 14: Define material properties.

To define **material properties** for this analysis, there is only one material for the bracket, A36 Steel, with given values for Young's modulus of elasticity and Poisson's ratio.

1. **Main Menu> Preprocessor> Material Props> Material Models**
2. Double-click on Structural, Linear, Elastic, Isotropic. →
3. Enter 30e6 for EX. →
4. Enter .27 for PRXY. →
5. OK to define material property set and close the dialog box. →
6. **Material> Exit** →

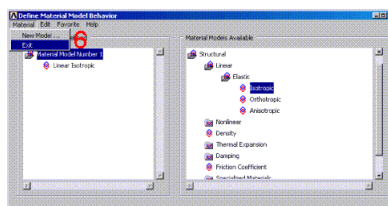
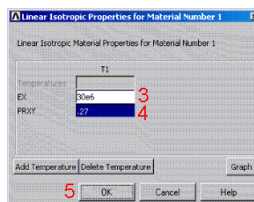
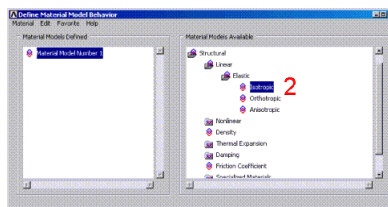

2.1.4.3. Step 15: Define element types and options.

In any analysis, you need to select from a library of **element types** and define the appropriate ones for your analysis.

For this analysis, you will use only one element type, **PLANE82**, which is a 2-D, quadratic, structural, **higher-order element**. The choice of a higher-order element here allows you to have a coarser mesh than with lower-order elements while still maintaining solution accuracy. Also, ANSYS will generate some triangle shaped elements in the mesh that would otherwise be inaccurate if you used lower-order elements (**PLANE42**). You will need to specify plane stress with thickness as an option for **PLANE82**. (You will define the thickness as a real constant in the next step.)

1. **Main Menu> Preprocessor> Element Type> Add/Edit/Delete**
2. Add an element type. →
3. Structural solid family of elements. →
4. Choose the 8-node quad (**PLANE82**). →
5. OK to apply the element type and close the dialog box. →
6. **Options** for **PLANE82** are to be defined. →
7. Choose plane stress with thickness option for element behavior. →
8. OK to specify options and close the options dialog box. →
9. Close the element type dialog box. →

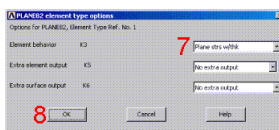
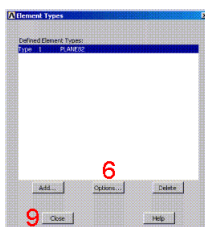
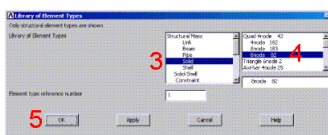
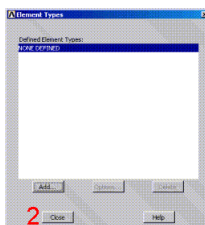

2.1.4.4. Step 16: Define real constants.

For this analysis, since the assumption is plane stress with thickness, you will enter the thickness as a **real constant** for **PLANE82**. To find out more information about **PLANE82**, you will use the ANSYS Help System in this step by clicking on a Help button from within a dialog box.

1. **Main Menu> Preprocessor> Real Constants> Add/Edit/Delete**
2. Add a real constant set. →
3. OK for **PLANE82**. →

Before clicking on the Help button in the next step, you should be aware

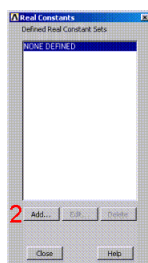

that the help information may appear in the same window as this tutorial, *replacing* the contents of the tutorial. After reading the help information, click on the Back button to return to this tutorial. If the help information appears in a *separate* window from the tutorial, minimize or close the help window after you read the help information.

4. Help to get help on PLANE82. →
5. Hold left mouse button down to scroll through element description.
6. If the help information replaced the tutorial, click on the Back button to return to the tutorial.
7. Enter .5 for THK. →
8. OK to define the real constant and close the dialog box. →
9. Close the real constant dialog box. →

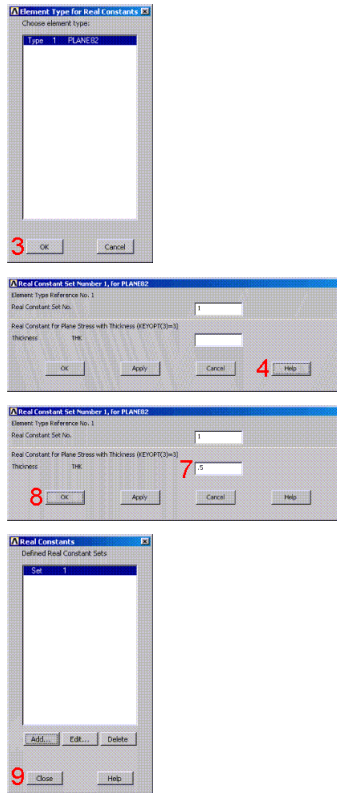

2.1.5. Generate Mesh

2.1.5.1. Step 17: Mesh the area.

One nice feature of the ANSYS program is that you can automatically mesh the model without specifying any mesh size controls. This is using what is called a **default mesh**. If you're not sure how to determine the mesh density, let ANSYS try it first! Meshing this model with a default mesh however, generates more elements than are allowed in the ANSYS ED program. Instead you will specify a global element size to control overall mesh density.

1. **Main Menu> Preprocessor> Meshing> Mesh Tool**
2. Set Global Size control. →
3. Type in 0.5. →
4. OK. →
5. Choose Area Meshing. →
6. Click on Mesh. →
7. Pick All for the area to be meshed (in picking menu). Close any warning messages that appear.
8. Close the Mesh Tool. →

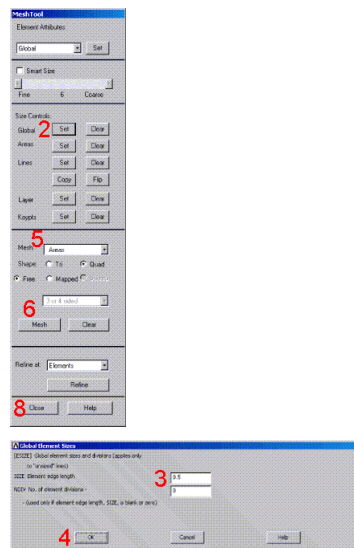

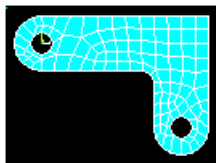

Note

The mesh you see on your screen may vary slightly from the mesh shown here. As a result of this, you may see slightly different results during postprocessing. For a discussion of results accuracy, see [Planning Your Approach](#) in the *Modeling and Meshing Guide*.

2.1.5.2. Step 18: Save the database as mesh.db.

Here again, you will save the database to a named file, this time *mesh.db*.

1. **Utility Menu> File> Save as**
2. Enter *mesh.db* for database file name.
→
3. OK to save file and close dialog box. →

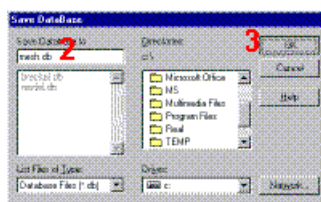

2.1.6. Apply Loads

The beginning of the [solution](#) phase.

A new, static analysis is the default, so you will not need to specify analysis type for this problem. Also, there are no [analysis options](#) for this problem.

2.1.6.1. Step 19: Apply displacement constraints.

You can apply displacement constraints directly to lines.

1. **Main Menu> Solution> Define Loads> Apply> Structural> Displacement> On Lines**
2. Pick the four lines around left-hand hole (Line numbers 10, 9, 11, 12).
→

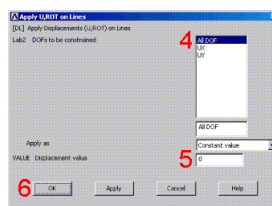
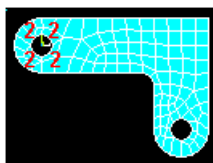

3. OK (in picking menu).
4. Click on All DOF. →
5. Enter 0 for zero displacement. →
6. OK to apply constraints and close dialog box. →

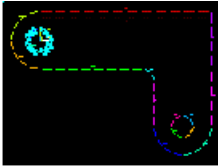
7. **Utility Menu> Plot Lines**8. Toolbar: **SAVE_DB**.**2.1.6.2. Step 20: Apply pressure load.**

Now apply the tapered pressure load to the bottom, right-hand pin hole. ("Tapered" here means varying linearly.) Note that when a circle is created in ANSYS, four lines define the perimeter. Therefore, apply the pressure to *two* lines making up the lower half of the circle. Since the pressure tapers from a maximum value (500 psi) at the bottom of the circle to a minimum value (50 psi) at the sides, apply pressure in two separate steps, with reverse tapering values for each line.

The ANSYS convention for pressure loading is that a *positive* load value represents pressure *into* the surface (compressive).

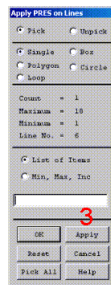
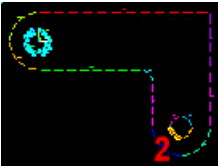
1. **Main Menu> Solution> Define Loads> Apply> Structural> Pressure> On Lines**2. Pick line defining bottom *left* part of the circle (line 6).

3. Apply. →

4. Enter 50 for VALUE. →

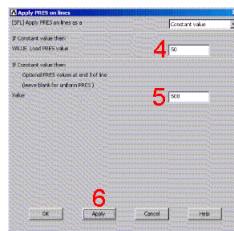

5. Enter 500 for optional value. →

6. Apply. →

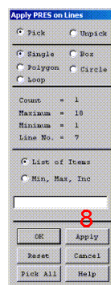
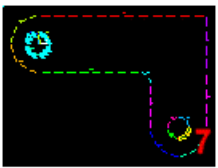
7. Pick line defining bottom *right* part of circle (line 7).

8. Apply. →

9. Enter 500 for VALUE. →

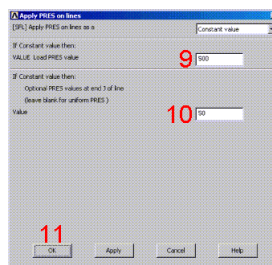

10. Enter 50 for optional value. →

11. OK. →

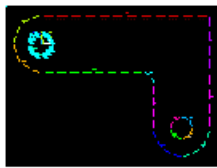

12. Toolbar: **SAVE_DB**.

2.1.7. Obtain Solution

2.1.7.1. Step 21: Solve.

1. **Main Menu> Solution> Solve> Current LS**
2. Review the information in the status window, then choose **File> Close** (Windows), or **Close** (X11/Motif), to close the window. →
3. OK to begin the solution. → Choose Yes to any Verify messages that appear.
4. Close the information window when solution is done. →

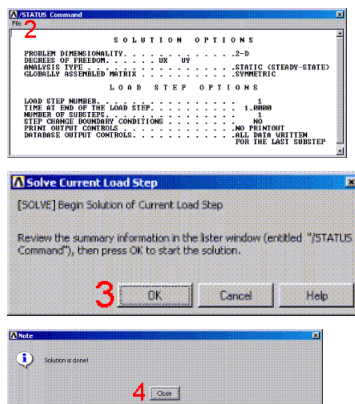

ANSYS stores the results of this one load step problem in the database and in the results file, *Jobname.RST* (or *Jobname.RTH* for thermal, *Jobname.RMG* for magnetic, and *Jobname.RFL* for fluid analyses). The database can actually contain only one set of results at any given time, so in a multiple load step or multiple substep analysis, ANSYS stores only the *final* solution in the database. ANSYS stores *all* solutions in the results file.

2.1.8. Review Results

The beginning of the [postprocessing](#) phase.

Note

The results you see may vary slightly from what is shown here due to variations in the mesh.

2.1.8.1. Step 22: Enter the general postprocessor and read in the results.

1. **Main Menu> General Postproc> Read Results> First Set**

2.1.8.2. Step 23: Plot the deformed shape.

1. **Main Menu> General Postproc> Plot Results> Deformed Shape**
2. Choose Def + undeformed. →
3. OK. →

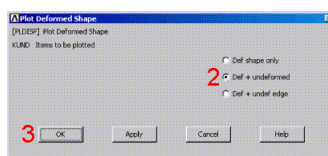

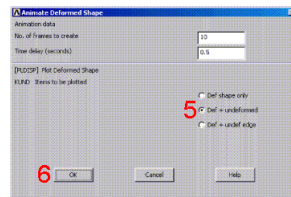
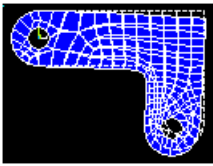

You can also produce an animated version of the deformed shape:

4. **Utility Menu> PlotCtrls> Animate> Deformed Shape**

5. Choose Def + undeformed. ➔

6. OK. ➔

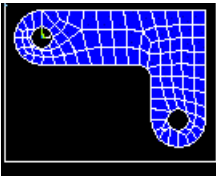

7. Make choices in the Animation Controller (not shown), if necessary, then choose Close.

2.1.8.3. Step 24: Plot the von Mises equivalent stress.

1. **Main Menu> General Postproc> Plot Results> Contour Plot> Nodal Solu**

2. Choose Stress item to be contoured. ➔

3. Scroll down and choose von Mises (SEQV). ➔

4. OK. ➔

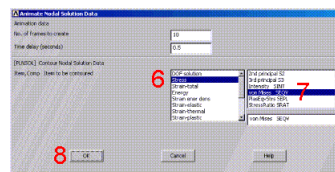
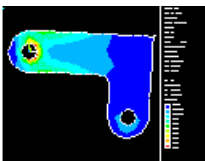
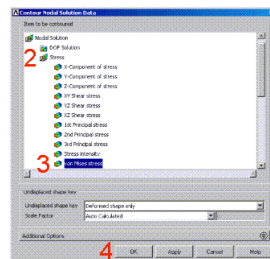

You can also produce an animated version of these results:

5. **Utility Menu> PlotCtrls> Animate> Deformed Results**

6. Choose Stress item to be contoured. ➔

7. Scroll down and choose von Mises (SEQV). ➔

8. OK. ➔

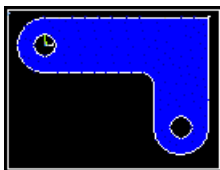

9. Make choices in the Animation Controller (not shown), if necessary, then choose Close.

2.1.8.4. Step 25: List reaction solution.

1. **Main Menu> General Postproc> List Results> Reaction Solu**
2. OK to list all items and close the dialog box. →
3. Scroll down and find the total vertical force, FY. →
4. **File> Close** (Windows), or **Close** (X11/Motif), to close the window. →

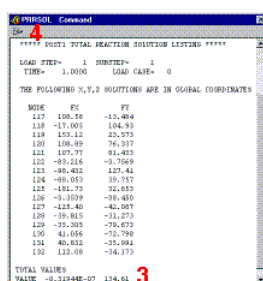
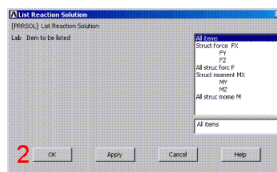

The value of 134.61 is comparable to the total pin load force.

Note

The values shown are representative and may vary from the values you obtain.

There are many other options available for reviewing results in the general postprocessor. You'll see some of these demonstrated in other tutorials. You have finished the analysis. Exit the program in the next step.

2.1.8.5. Step 26: Exit the ANSYS program.

When exiting the ANSYS program, you can save the geometry and loads portions of the database (default), save geometry, loads, and solution data (one set of results only), save geometry, loads, solution data, and postprocessing data (i.e., save everything), or save nothing. You can save nothing here, but you should be sure to use one of the other save options if you want to keep the ANSYS data files.

1. Toolbar: **Quit**.
2. Choose Quit - No Save! →
3. OK. →

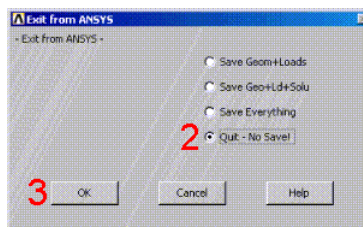

Congratulations! You have completed this tutorial.

Even though you have exited the ANSYS program, you can still view animations [using the ANSYS ANIMATE program](#). The ANIMATE program runs only on the PC and is extremely useful for:

- Viewing ANSYS animations on a PC regardless of whether the files were created on a PC (AVI files) or on a UNIX workstation (ANIM files).
- Converting ANIM files to AVI files.
- Sending animations over the web.

Chapter 3: Thermal Tutorial

Solidification of a Casting

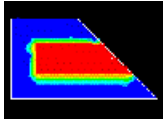

- Problem Specification
- Problem Description
- Prepare for a Thermal Analysis
- Input Geometry
- Define Materials
- Generate Mesh
- Apply Loads
- Obtain Solution
- Review Results

3.1. Solidification of a Casting

3.1.1. Problem Specification

Applicable ANSYS Products:	ANSYS Multiphysics, ANSYS Mechanical, ANSYS ED
Level of Difficulty:	moderate
Interactive Time Required:	60 to 90 minutes
Discipline:	thermal
Analysis Type:	nonlinear transient
Element Types Used:	PLANE55
ANSYS Features Demonstrated:	conduction, convection, phase change, selecting, solution control, time-history postprocessing, use of a "get function"
Applicable Help Available:	Transient Thermal Analysis in the <i>Thermal Analysis Guide</i> , PLANE55 in the <i>Element Reference</i> .

3.1.2. Problem Description

This is a transient heat transfer analysis of a casting process. The objective is to track the temperature distribution in the steel casting and the mold during the solidification process, which occurs over a duration of

4 hours. The casting is made in an L-shaped sand mold with 4 inch thick walls. Convection occurs between the sand mold and the ambient air.

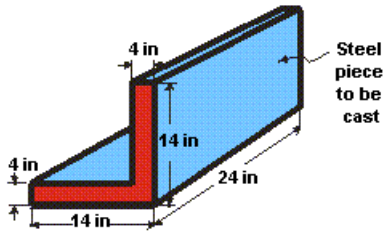

3.1.2.1. Given

<i>Material Properties for Sand</i>	
Conductivity (KXX)	0.025 Btu/(hr-in-°F)
Density (DENS)	0.054 lb/in ³
Specific heat (C)	0.28 Btu/(lb-°F)

<i>Conductivity (KXX) for Steel</i>	
at 0°F	1.44 Btu/(hr-in-°F)
at 2643°F	1.54
at 2750°F	1.22
at 2875°F	1.22

<i>Enthalpy (ENTH) for Steel</i>	
at 0°F	0.0 Btu/in ³
at 2643°F	128.1
at 2750°F	163.8
at 2875°F	174.2

<i>Initial Conditions</i>	
Temperature of steel	2875 °F
Temperature of sand	80 °F

<i>Convection Properties</i>	
Film coefficient	0.014 Btu/(hr-in ² -°F)
Ambient temperature	80 °F

3.1.2.2. Approach and Assumptions

You will perform a 2-D analysis of a one unit thick slice. Half symmetry is used to reduce the size of the model. The lower half is the portion you will model.

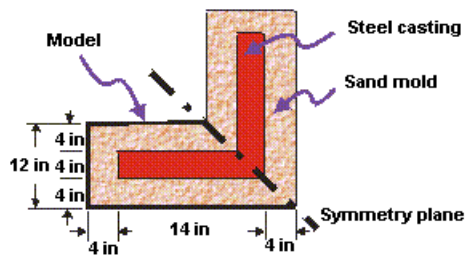

The mold material (sand) has constant material properties. The casting (steel) has temperature-dependent thermal conductivity and enthalpy; both are input in a table of values versus temperature. The enthalpy property table captures the latent heat capacity of the metal as it solidifies. Radiation effects are ignored.

Solution control is used to establish several nonlinear options, including automatic time stepping. Automatic time stepping determines the proper time step increments needed to converge the phase change nonlinearity. This means that smaller time step sizes will be used during the transition from molten metal to solid state.

3.1.2.3. Summary of Steps

Use the information in the problem description and the steps below as a guideline in solving the problem on your own. Or, use the detailed interactive step-by-step solution by choosing the link for step 1.

Prepare for a Thermal Analysis

1. Set preferences.

Input Geometry

2. Read in the geometry of the casting.

Define Materials

3. Define material properties.
4. Plot material properties vs. temperature.
5. Define element type.

Generate Mesh

6. Mesh the model.

Apply Loads

7. Apply convection loads on the exposed boundary lines.

Obtain Solution

8. Define analysis type.
9. Examine solution control.
10. Specify initial conditions for the transient.

11. Set time, time step size, and related parameters.
12. Set output controls.
13. Solve.

Review Results

14. Enter the time-history postprocessor and define variables.
15. Plot temperature vs. time.
16. Set up to animate the results.
17. Animate the results.
18. Exit the ANSYS program.

3.1.3. Prepare for a Thermal Analysis

3.1.3.1. Step 1: Set preferences.

To Set Preferences:

1. **Main Menu> Preferences**
2. (check) "Individual discipline(s) to show in the GUI" = Thermal
3. [OK]

3.1.4. Input Geometry

3.1.4.1. Step 2: Read in the geometry of the casting.

You will begin by reading in a file that includes the model of the casting.

1. **Utility Menu> File> Read Input from ...**
2. File name: `casting.inp`

UNIX version:

```
/ansys_inc/v121/ansys/data/models/casting.inp
```

PC version:

```
\Program Files\Ansys Inc\V121\ANSYS\data\models\casting.inp
```

3. [OK]

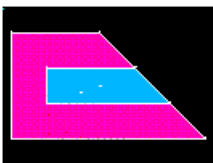

3.1.5. Define Materials

3.1.5.1. Step 3: Define material properties.

Define the sand mold **material properties** as material number 1. These are *not* functions of temperature.

1. **Main Menu> Preprocessor> Material Props> Material Models**
2. (double-click) "Thermal"; then "Conductivity"; then "Isotropic"
3. "KXX" = 0.025
4. [OK]
5. (double-click) "Specific Heat"
6. "C" = 0.28
7. [OK]
8. (double-click) "Density"
9. "DENS" = 0.54
10. [OK]

Note

PC Users: You can view a demo on defining one material model by pointing your Internet Explorer browser to the following URL address: http://www.ansys.com/techmedia/one_material.html

The metal casting is defined as material number 2. These properties change significantly as the metal cools down from the liquid phase to the solid phase. Therefore, they are entered in a table of properties versus temperature.

First define the temperature dependent thermal conductivity.

11. **Material> New Model**
12. "Define Material ID" = 2
13. [OK]
14. (double-click) "Isotropic"
15. [Add Temperature] three times to create fields for the four temperatures.
16. "T1" = 0
17. "T2" = 2643
18. "T3" = 2750
19. "T4" = 2875
20. "KXX" at "T1" = 1.44
21. "KXX" at "T2" = 1.54
22. "KXX" at "T3" = 1.22
23. "KXX" at "T4" = 1.22

You will now copy the four temperatures so you will be able to paste them into the Enthalpy dialog box.

24. Select the temperatures by holding the left mouse button and dragging across the temperature row so that the row is highlighted.
25. [Ctrl] then [c] to copy the temperatures.
26. [OK]

Next, define the temperature dependent enthalpy.

27. (double-click) "Enthalpy"
28. [Add Temperature] three times to create fields for the four temperatures.
29. Paste the temperatures into the dialog box by highlighting the T1 temperature field, and pressing [Ctrl] then [v].
30. "ENTH" at "T1" = 0
31. "ENTH" at "T2" = 128.1
32. "ENTH" at "T3" = 163.8
33. "ENTH" at "T4" = 174.2
34. [OK]

Note

PC Users: You can view a demo on adding a temperature dependent material model by pointing your Internet Explorer browser to the following URL address: http://www.ansys.com/techmedia/add_temp_material.html

3.1.5.2. Step 4: Plot material properties vs. temperature.

1. (double-click) "Thermal conduct. (iso)" under **Material Model Number 2**.
2. [Graph]
3. [OK]

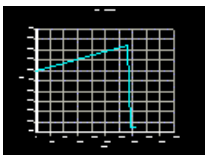

Note

PC Users: You can view a demo on graphing a temperature dependent material model by pointing your Internet Explorer browser to the following URL address: http://www.ansys.com/techmedia/graph_temp_material.html

4. (double-click) "Enthalpy" under the right or left window.
5. [Graph]
6. [OK]

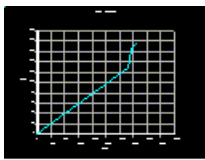

7. **Material> Exit**
8. Toolbar: **SAVE_DB**

3.1.5.3. Step 5: Define element type.

You will now define the [element type](#) as PLANE55.

1. **Main Menu> Preprocessor> Element Type> Add/Edit/Delete**
2. [Add ...]
3. "Thermal Solid" (left column)
4. "Quad 4node 55" (right column)
5. [OK]
6. [Close]
7. Toolbar: **SAVE_DB**

3.1.6. Generate Mesh

3.1.6.1. Step 6: Mesh the model.

1. **Utility Menu> Plot> Areas**

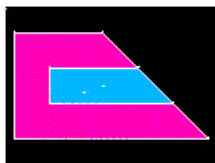

Specify a SmartSize of 4. This will allow a slightly finer mesh than the default and yet the resulting number of elements will be within the ANSYS ED program limits for the maximum number of elements.

2. **Main Menu> Preprocessor> Meshing> MeshTool**
3. (check) "Smart Size"
4. (slide) "Fine Course" = 4
5. [Mesh]

Mesh the mold area first. Note that the material attribute reference number defaults to 1 and there is no need to set attributes before meshing the area.

6. Pick the mold area A5 (Hint: Place the mouse cursor on top of the A5 label when you pick -- this is the picking "hot spot," based on the centroid of the area.).

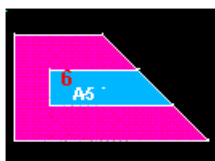

7. [OK]

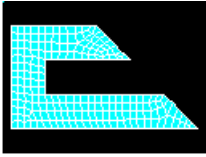

Before meshing the casting area, set the material attribute to that of steel (material 2).

8. (drop down in MeshTool) "Element Attributes" = Global, then [Set]
9. (drop down) "Material number" = 2
10. [OK]
11. **Utility Menu> Plot> Areas**
12. [Mesh] in MeshTool
13. Pick area A4

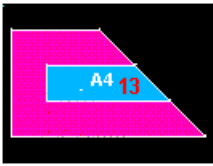

14. [OK]
15. [Close] in MeshTool
16. **Utility Menu> Plot> Elements**

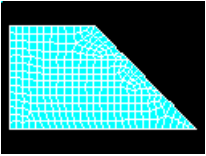

Note: The mesh you obtain may vary slightly from the mesh shown here. As a result of this, you may see slightly different results during postprocessing. For a discussion of results accuracy, see [Planning Your Approach](#) in the *Modeling and Meshing Guide*.

To verify that the elements have the right materials, plot them with different colors for different materials.

17. **Utility Menu> PlotCtrls> Numbering**
18. (drop down) "Elem / Attrib numbering" = Material numbers
19. [OK]

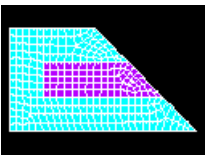

Note: the elements of material 1 form the sand mold. The elements of material 2 form the steel casting. You can also plot the elements showing materials in different colors without displaying the associated material numbers.

20. **Utility Menu> PlotCtrls> Numbering**
21. (drop down) "Numbering shown with" = Colors only
22. [OK]

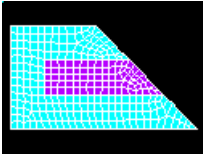

23. Toolbar: **SAVE_DB**

3.1.7. Apply Loads

3.1.7.1. Step 7: Apply convection loads on the exposed boundary lines.

Apply the convection to the lines of the solid model. Loads applied to solid modeling entities are automatically transferred to the finite element model during solution.

1. **Utility Menu> Plot> Lines**
2. **Main Menu> Preprocessor> Loads> Define Loads> Apply> Thermal> Convection> On Lines**
3. Pick the three lines that are exposed to ambient air.

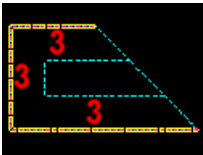

4. [OK]
5. "Film coefficient" = 0.014
6. "Bulk temperature" = 80
7. [OK]

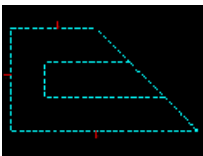

8. Toolbar: **SAVE_DB**

3.1.8. Obtain Solution

3.1.8.1. Step 8: Define analysis type.

1. **Main Menu> Solution> Analysis Type> New Analysis**
2. (check) "Type of analysis" = Transient
3. [OK]
4. (check) "Solution method" = Full
5. [OK]

3.1.8.2. Step 9: Examine solution control.

The Approach and Assumptions section of this tutorial mentioned that solution control is used to establish several nonlinear options. In this step, you will be directed to the online help for solution control so you can examine the details of this feature.

You will access this help topic by clicking on the Help button from within the Nonlinear Solution Control dialog box.

1. **Main Menu> Solution> Load Step Opts> Solution Ctrl**

Note that solution control is on by default.

Before clicking on the Help button in the next step, you should be aware that the help information may appear in the same window as this tutorial, *replacing* the contents of the tutorial. If this is the case, after reading the help information, you will need to click on the Back button to return to this tutorial. If the help information appears in a *separate window* from the tutorial, you can minimize or close the help window after you read the help information.

2. [Help] then read the details on Solution Control.
3. If the help information replaced the tutorial, click on the Back button to return to the tutorial. If the help information appears in a separate window, you can close or minimize that window.
4. [Cancel] to remove the dialog box.

3.1.8.3. Step 10: Specify initial conditions for the transient.

The mold is initially at an ambient temperature of 80°F and the molten metal is at 2875°F. Use select entities to obtain the correct set of nodes on which to apply the initial temperatures. First select the casting area, then select the nodes within that area and apply the initial molten temperature to those nodes. Next, invert the selected set of nodes and apply the ambient temperature to the mold nodes.

Start by plotting areas.

1. **Utility Menu> Plot> Areas**
2. **Utility Menu> Select> Entities**
3. (first drop down) "Areas"
4. [OK]
5. Pick area A4, which is the casting.

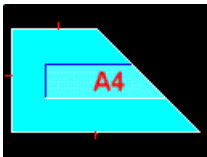

6. [OK]
7. **Utility Menu> Select> Everything Below> Selected Areas**
8. **Utility Menu> Plot> Nodes**



9. **Main Menu> Solution> Define Loads> Apply> Initial Condit'n> Define**
10. [Pick All] to use *selected* nodes.
11. (drop down) "DOF to be specified" = TEMP
12. "Initial value of DOF" = 2875

13. [OK]
14. **Utility Menu> Select> Entities**
15. (first drop down) "Nodes"
16. (second drop down) "Attached to"
17. (check) "Areas, all"
18. [Invert] This is an action command; the selected set of nodes is immediately inverted.
19. [Cancel] to close the dialog box.
20. **Utility Menu> Plot> Nodes**



21. **Main Menu> Solution> Define Loads> Apply> Initial Condit'n> Define**
22. [Pick All] to use all selected nodes.
23. "Initial value of DOF" = 80
24. [OK]

Remember to always select Everything again when you are finished selecting the nodes!

25. **Utility Menu> Select> Everything**
26. Toolbar: **SAVE_DB**

3.1.8.4. Step 11: Set time, time step size, and related parameters.

Stepped boundary conditions simulate the sudden contact of molten metal at 2875 °F with the mold at ambient temperature. The program will choose automatic time stepping that will enable the time step size to be modified depending on the severity of nonlinearities in the system (for example, it will take smaller time steps while going through the phase change). The maximum and minimum time step sizes represent the limits for this automated procedure.

1. **Main Menu> Solution> Load Step Opts> Time/Frequenc> Time-Time Step**
2. "Time at end of load step" = 4

Note

This represents 4 *hours*.

3. "Time step size" = 0.01
4. (check) "Stepped or ramped b. c." = Stepped
5. "Minimum time step size" = 0.001
6. "Maximum time step size" = 0.25
7. [OK]

3.1.8.5. Step 12: Set output controls.

1. **Main Menu> Solution> Load Step Opts> OutputCtrls> DB/Results File**
2. (check) "File write frequency" = Every substep
3. [OK]
4. Toolbar: **SAVE_DB**

3.1.8.6. Step 13: Solve.

1. **Main Menu> Solution> Solve> Current LS**
2. Review the information in the status window, then choose. **File> Close (Windows)**, or **Close (X11/Motif)**, to close the window.

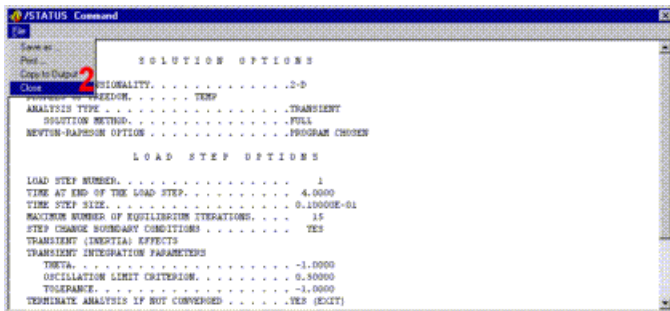

3. [OK] to initiate the solution.
4. [Close] when the solution is done.

While ANSYS is solving the analysis, the Graphical Solution Tracking (GST) monitor plots the "Absolute Convergence Norm" as a function of the "Cumulative Iteration Number." Notice that the solution is assumed to have converged for values less than or equal to the convergence criteria.

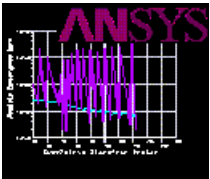

3.1.9. Review Results

3.1.9.1. Step 14: Enter the time-history postprocessor and define variables.

Use the time-history postprocessor to look at the variation of temperature with respect to time at one point on the casting (on the symmetry plane).

1. **Utility Menu> PlotCtrls> Numbering**
2. (check) "Node numbers" = On
3. (drop down) "Numbers shown with" = Colors & numbers
4. [OK]
5. **Utility Menu> Plot> Elements**

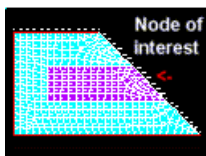

The node at the center of the casting on the symmetry plane is the node of interest. Use a "get function" to define a variable equal to the value of the node number at the location of interest (16,6,0). By using a variable to identify the node at the center point, the analysis will be more flexible in that the center node will always be used even if the mesh, and therefore node numbers, change.

6. **Utility Menu> Parameters> Scalar Parameters**

7. "Selection"=cntr_pt = node (16,6,0)

8. [Accept]

Note the center point node number. This number can vary due to differences in the mesh.

9. [Close]

10. **Main Menu> TimeHist Postproc**

11. [+] to add data.

12. (double-click) "Nodal Solution", then "DOF Solution", then "Temperature"

13. "Variable Name" = center

14. [OK]

15. Type cntr_pt in the picker, then press Enter.

16. [OK] in the picker.

17. **File> Close**

3.1.9.2. Step 15: Plot temperature vs. time.

1. **Main Menu> TimeHist Postpro> Graph Variables**

2. "1st variable to graph" = 2

3. [OK] to plot the results at cntr_point as a function of time.

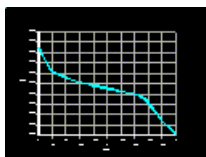

Notice from this graph that the solidification region is approximately between 2643°F and 2750°F. Your graph may vary slightly.

3.1.9.3. Step 16: Set up to animate the results.

Next, animate the solidification of the molten metal. To better visualize the solidification process, specify three contours. One will represent the molten metal (T greater than 2750 °F), one will represent the solidified metal (T less than 2643 °F), and the third will represent everything in between.

But first, to perform an animation, you must enter the General Postprocessor and read the first set of results.

1. **Main Menu> General Postproc> Read Results> First Set**

2. **Utility Menu> PlotCtrls> Numbering**
3. (check) "Node numbers" = Off
4. (drop down) "Elem / Attrib numbering" = No numbering
5. (drop down) "Replot upon OK/Apply?" = Do not replot
6. [OK]
7. **Utility Menu> Plot> Elements**

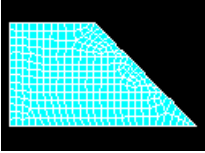

8. **Utility Menu> PlotCtrls> Style> Contours> Non_uniform Contours**

Note that as indicated in the brackets at the upper left corner of the dialog box, the command to specify non_uniform contours is **/CVAL**. You will later use this command to set the contours to their default setting.

9. "V1" = 2643
10. "V2" = 2750
11. "V3" = 3000

Note

These three values represent the upper bounds of the first, second, and third contours, respectively.

12. [OK]

3.1.9.4. Step 17: Animate the results.

[Note for UNIX systems only: To capture the animation sequence in terminal segment memory, it is necessary to reduce the size of the Graphics Window or you will run out of terminal memory. Although this depends on your particular system, and the size of the animation file to be created, for this exercise it is suggested that the ratio of the original window size to the reduced window size should be about 2:1.]

Procedure on all systems:

1. **Utility Menu> PlotCtrls> Animate> Over Time**
2. "Number of animation frames" = 30
3. (check) "Auto contour scaling" = Off
4. [OK]

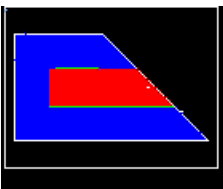

During the animation, notice the three separate colors - red for temperatures greater than 2750 °F (molten steel), green for temperatures between 2643 °F and 2750 °F (the "mushy" phase change region), and blue for temperatures below 2643 °F (the solidified steel and the sand mold). As you would expect, the last region to solidify is the material at the center of the casting. (Remember that a symmetry model was used.)

5. Make choices in the Animation Controller (not shown), if necessary, then [Close].

To visualize the temperature distribution throughout the model over the 4 hour span, animate the temperature distribution with the default contour settings. To change the contour settings back to their default value, simply type **/CVAL** in the ANSYS Input Window. Note that **/CVAL** is the command you used earlier to set non_uniform contours. The same outcome can be achieved by going back to the Non_Uniform Contours window and setting all the values to zero.

6. Type **/CVAL**, then press Enter.
7. **Utility Menu> PlotCtrls> Animate> Over Time**
8. [OK]

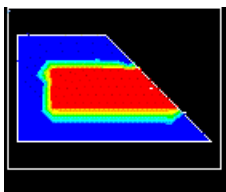

9. Make choices in the Animation Controller (not shown), if necessary, then [Close].

3.1.9.5. Step 18: Exit the ANSYS program.

1. Toolbar: **QUIT**
2. (check) "Quit - No Save!"
3. [OK]

Congratulations! You have completed this tutorial.

Even though you have exited the ANSYS program, you can still view animations [using the ANSYS ANIMATE program](#). The ANIMATE program runs only on the PC and is extremely useful for:

- Viewing ANSYS animations on a PC regardless of whether the files were created on a PC (AVI files) or on a UNIX workstation (ANIM files).
- Converting ANIM files to AVI files.
- Sending animations over the web.

Chapter 4: Electromagnetics Tutorial

Magnetic Analysis of a Solenoid Actuator

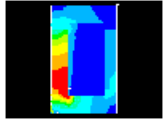

- Problem Specification
- Problem Description
- Input Geometry
- Define Material
- Generate Mesh
- Apply Loads
- Obtain Solution
- Review Results

4.1. Magnetic Analysis of a Solenoid Actuator

4.1.1. Problem Specification

Applicable ANSYS Products:	ANSYS Multiphysics, ANSYS Emag, ANSYS ED
Level of Difficulty:	easy
Interactive Time Required:	60 to 75 minutes
Discipline:	electromagnetics
Analysis Type:	linear static
Element Types Used:	PLANE13
ANSYS Features Demonstrated:	axisymmetry, vector plots, element table operations, path operations
Applicable Help Available:	Two-dimensional Static Magnetic Analysis in the <i>Low-Frequency Electromagnetic Analysis Guide</i> , PLANE13 in the <i>Element Reference</i> .

4.1.2. Problem Description

A solenoid actuator is to be analyzed as a 2-D axisymmetric model. For the given current, determine the force on the armature.

4.1.2.1. Given

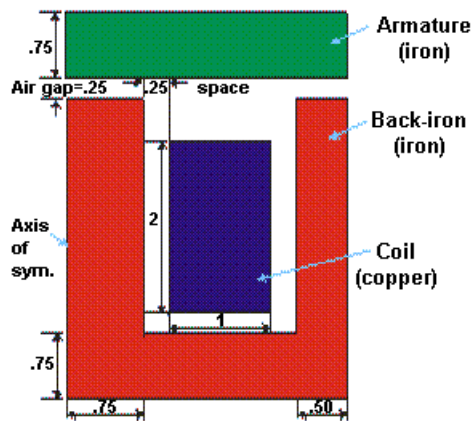

The dimensions of the solenoid actuator are in centimeters. The *armature* is the moving component of the actuator. The *back-iron* is the stationary iron component of the actuator that completes the magnetic circuit around the coil. The stranded, wound *coil* of 650 windings with 1 amp/turn supplies the predefined current. The current per winding is 1 amp. The *air-gap* is the thin rectangular region of air between the armature and the pole faces of the back-iron.

4.1.2.2. Approach and Assumptions

The magnetic flux produced by the coil current is assumed to be so small that no saturation of the iron occurs. This allows a single iteration linear analysis. The flux leakage out of the iron at the perimeter of the model is assumed to be negligible. This assumption is made simple to keep the model small. The model would normally be created with a layer of air surrounding the iron equal to or greater than the maximum radius of the iron.

The air gap is modeled so that a quadrilateral mesh is possible. A quadrilateral mesh allows for a uniform thickness of the air elements adjacent to the armature where the virtual work force calculation is performed. This is desirable for an accurate force calculation.

The program requires the current to be input in the form of current density (current over the area of the coil).

The assumption of no leakage at the perimeter of the model means that the flux will be acting parallel to this surface. This assumption is enforced by the "flux parallel" boundary condition placed around the model. This boundary condition is used for models in which the flux is contained in an iron circuit.

Forces for the virtual work calculation are stored in an element table and then summed. The force is also calculated by the Maxwell Stress Tensor method and the two values are found to be relatively close.

4.1.2.3. Summary of Steps

Use the information in the problem description and the steps below as a guideline in solving the problem on your own. Or, use the detailed interactive step-by-step solution by choosing the link for step 1.

Input Geometry

1. [Read in geometry input file.](#)

Define Materials

2. Set preferences.
3. Specify material properties.

Generate Mesh

4. Define element type and options.
5. Assign material property attributes.
6. Specify meshing-size controls on air gap.
7. Mesh the model using the MeshTool.
8. Scale model to meters for solution.

Apply Loads

9. Define the armature as a component.
10. Apply force boundary conditions to armature.
11. Apply the current density.
12. Obtain a flux parallel field solution.

Obtain Solution

13. Solve.

Review Results

14. Plot the flux lines in the model.
15. Summarize magnetic forces.
16. Plot the flux density as vectors.
17. Plot the magnitude of the flux density.
18. Exit the ANSYS program.

4.1.3. Input Geometry

4.1.3.1. Step 1: Read in geometry input file.

You will begin by reading in a file that includes the model.

1. **Utility Menu> File> Read Input from ...**
2. File name: `solenoid.inp`

UNIX version:

```
/ansys_inc/v121/ansys/data/models/solenoid.inp
```

PC version:

```
\Program Files\Ansys Inc\V121\ANSYS\data\models\solenoid.inp
```

3. [OK]

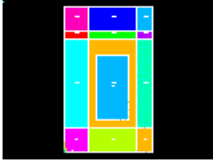

4.1.4. Define Materials

4.1.4.1. Step 2: Set preferences.

You will now set [preferences](#) in order to filter quantities that pertain to this discipline only.

1. **Main Menu> Preferences**
2. (check) "Magnetic-Nodal"
3. [OK]

4.1.4.2. Step 3: Specify material properties.

Now specify the [material properties](#) for the magnetic permeability of air, back-iron, coil, and armature. For simplicity, all material properties are assumed to be linear. (Typically, iron is input as a nonlinear B-H curve.) Material 1 will be used for the air elements. Material 2 will be used for the back-iron elements. Material 3 will be used for the coil elements. Material 4 will be used for the armature elements.

1. **Main Menu> Preprocessor> Material Props> Material Models**
2. (double-click) "Electromagnetics," then "Relative Permeability," then "Constant"
3. "MURX" = 1
4. [OK]
5. **Edit> Copy**
6. [OK] to copy Material Model Number 1 to become Material Model Number 2.
7. (double-click) "Material Model Number 2," then "Permeability (Constant)"
8. "MURX" = 1000
9. [OK]
10. **Edit> Copy**
11. "from Material Number" = 1
12. "to Material Number" = 3
13. [OK]
14. **Edit> Copy**
15. "from Material Number" = 2
16. "to Material Number" = 4

17. [OK]
18. (double-click) "Material Model Number 4"; then "Permeability (Constant)"
19. "MURX" = 2000
20. [OK]
21. **Material> Exit**
22. **Utility Menu> List> Properties> All Materials**
23. Review the list of materials, then:

File> Close (Windows),

or

Close (X11/Motif) to close the window.

4.1.5. Generate Mesh

4.1.5.1. Step 4: Define element types and options.

In this step you will define [element types](#) and specify [options](#) associated with these element types.

The [higher-order element PLANE53](#) is normally preferred, but to keep the model size small, use the lower-order element [PLANE13](#).

1. **Main Menu> Preprocessor> Element Type> Add/Edit/Delete**
2. [Add...]
3. "Magnetic Vector" (left column)
4. "Vect Quad 4nod13 (PLANE13)" (right column)
5. [OK]
6. [Options...]
7. (drop down) "Element behavior" = Axisymmetric
8. [OK]
9. [Close]

4.1.5.2. Step 5: Assign material properties.

Now assign [material properties](#) to air gaps, iron, coil, and armature areas.

1. **Main Menu> Preprocessor> Meshing> MeshTool**
2. (drop down) "Element Attributes" = Areas; then [Set]
3. Pick four areas of air gaps, A13, A14, A17, and A18 (the picking "hot spot" is at the area number label).

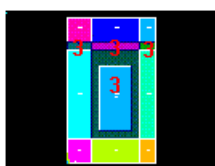

4. [OK]

5. (drop down) "Material number" = 1
6. [Apply]
7. Pick the five back-iron areas, A7, A8, A9, A11, A12.

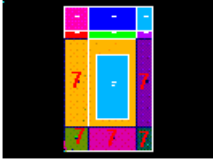

8. [OK]
9. (drop down) "Material number" = 2
10. [Apply]
11. Pick coil area, A4.

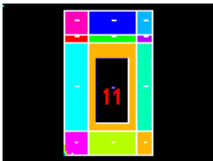

12. [OK]
13. (drop down) "Material number" = 3
14. [Apply]
15. Pick armature area, A10, A15, A16.



16. [OK]
17. (drop down) "Material number" = 4
18. [OK]
19. Toolbar: **SAVE_DB**

4.1.5.3. Step 6: Specify meshing-size controls on air gap.

Adjust meshing size controls to get two element divisions through the air gap.

1. Main Menu> Preprocessor> Meshing> Size Cntrl> ManualSize> Lines> Picked Lines
2. Pick four vertical lines through air gap.

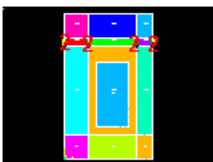

3. [OK]

4. "No. of element divisions" = 2
5. [OK]

4.1.5.4. Step 7: Mesh the model using the MeshTool.

1. "Size Control Global" = [Set]
2. "Element edge length" = 0.25
3. [OK]
4. (drop down) "Mesh" = Areas
5. [Mesh]
6. [Pick All]
7. [Close]

Note: Due to ANSYS ED FEA limitations, choose a coarse mesh. However, for production use, a finer mesh can be used, especially in the air-gap region.

8. **Utility Menu > PlotCtrls > Numbering**
9. (drop down) "Elem / attrib numbering" = Material numbers
10. [OK]

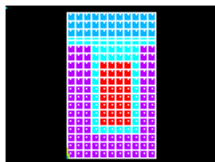

Note: Your mesh may vary slightly from the mesh shown here. As a result, you may see slightly different results during [postprocessing](#). For a discussion of results accuracy, see [Planning Your Approach](#) in the [Modeling and Meshing Guide](#).

4.1.5.5. Step 8: Scale model to meters for solution.

For a magnetic analysis, a consistent set of units must be used. In this tutorial, MKS units are used, so you must scale the model from centimeters to meters.

1. **Main Menu > Preprocessor > Modeling > Operate > Scale > Areas**
2. [Pick All]
3. "RX,R,Y,RZ Scale Factors" = 0.01, 0.01, 1
4. (drop down) "Existing areas will be" = Moved
5. [OK]
6. Toolbar: **SAVE_DB**

4.1.6. Apply Loads

4.1.6.1. Step 9: Define the armature as a component.

The armature can conveniently be defined as a component by selecting its elements.

1. **Utility Menu> Select> Entities**
2. (first drop down) "Elements"
3. (second drop down) "By Attributes"
4. "Min, Max, Inc" = 4
5. [OK]
6. **Utility Menu> Plot> Elements**

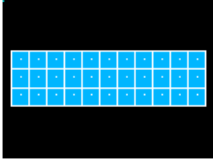

7. **Utility Menu> Select> Comp/Assembly> Create Component**
8. "Component name" = ARM
9. (drop down) "Component is made of" = Elements
10. [OK]

4.1.6.2. Step 10: Apply force boundary conditions to armature.

1. **Main Menu> Preprocessor> Loads> Define Loads> Apply> Magnetic> Flag> Comp. Force/Torq**
2. (highlight) "Component name" = ARM
3. [OK]
4. **Utility Menu> Select> Everything**
5. **Utility Menu> Plot> Elements**

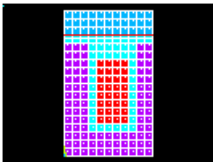

4.1.6.3. Step 11: Apply the current density.

The current density is defined as the number of coil windings times the current, divided by the coil area. This equals $(650)(1)/2$, or 325. To account for scaling from centimeters to meters, the calculated value needs to be divided by $.01^{**2}$.

1. **Utility Menu> Plot> Areas**

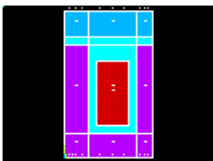

2. **Main Menu> Preprocessor> Loads> Define Loads> Apply> Magnetic> Excitation> Curr Density> On Areas**
3. Pick the coil area, which is the area in the center.

4. [OK]
5. "Curr density value" = $325/.01^{**2}$
6. [OK]

Close any warning messages that appear.

4.1.6.4. Step 12: Obtain a flux parallel field solution.

Apply a perimeter boundary condition to obtain a "flux parallel" field solution. This boundary condition assumes that the flux does not leak out of the iron at the perimeter of the model. Of course at the centerline this is true due to axisymmetry.

1. **Utility Menu> Plot> Lines**
2. **Main Menu> Preprocessor> Loads> Define Loads> Apply> Magnetic> Boundary> Vector Poten> Flux Par'l> On Lines**
3. Pick all lines around perimeter of model (14 lines).

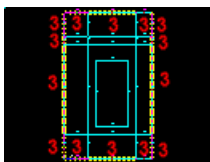

4. [OK]
5. Toolbar: **SAVE_DB**

4.1.7. Obtain Solution

4.1.7.1. Step 13: Solve.

1. **Main Menu> Solution> Solve> Electromagnet> Static Analysis> Opt & Solve**
2. [OK] to initiate the solution.
3. [Close] the information window when solution is done.

4.1.8. Review Results

4.1.8.1. Step 14: Plot the flux lines in the model.

Note that a certain amount of undesirable flux leakage occurs out of the back-iron.

1. **Main Menu> General Postproc> Plot Results> Contour Plot> 2D Flux Lines**
2. [OK]

Close any Notes or Warnings.



Your results may vary slightly from what is shown here due to variations in the mesh.

4.1.8.2. Step 15: Summarize magnetic forces.

1. **Main Menu> General Postproc> Elec & Mag Calc> Component Based> Force**
2. (highlight) "Component name(s)" = ARM
3. [OK]
4. Review the information, then choose:

File> Close (Windows),

or

Close (X11/Motif), to close the window.

4.1.8.3. Step 16: Plot the flux density as vectors.

1. **Main Menu> General Postproc> Plot Results> Vector Plot> Predefined**
2. "Flux & gradient" (left column)
3. "Mag flux dens B" (right column)
4. [OK]

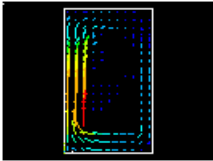

4.1.8.4. Step 17: Plot the magnitude of the flux density.

Plot the magnitude of the flux density without averaging the results across material discontinuities.

1. **Main Menu> General Postproc> Plot Results> Contour Plot> Nodal Solu**
2. Choose "Magnetic Flux Density," then "Magnetic flux density vector sum."
3. [OK]

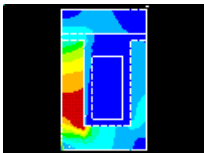

Next, you will see how the flux density is distributed throughout the entire actuator. Up to this point, the analysis and all associated plots have used the 2-D axisymmetric model, with the axis of symmetry aligned with the left vertical portion of the device. ANSYS will continue the analysis on the 2-D finite element model, but will allow you to produce a three-quarter expanded plot representation of the flux density throughout the device, based on the defined axisymmetry. This function is purely graphical. No changes to the database will be made when you produce this expanded plot.

4. **Utility Menu> PlotCtrls> Style> Symmetry Expansion> 2D Axi-Symmetric**
5. (check) "3/4 expansion"

6. [OK]

Obtain an isometric view for a more meaningful representation.

7. **Utility Menu> PlotCtrls> Pan,Zoom,Rotate**

8. [Iso]

9. [Close]

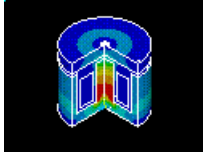

4.1.8.5. Step 18: Exit the ANSYS program.

1. Toolbar: **QUIT**

2. (check) "Quit - No Save!"

3. [OK]

Congratulations! You have completed this tutorial.

Chapter 5: Micro-Electromechanical System (MEMS) Tutorial

Multiphysics Analysis of a Thermal Actuator

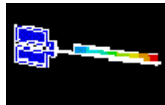

- Problem Specification
- Problem Description
- Import Geometry
- Define Material
- Generate Mesh
- Apply Loads
- Obtain Solution
- Review Results

5.1. Multiphysics Analysis of a Thermal Actuator

5.1.1. Problem Specification

Applicable ANSYS Products:	ANSYS Multiphysics
Level of Difficulty:	easy
Interactive Time Required:	approximately 30 minutes
Discipline:	structural, thermal, electric
Analysis Type:	static, nonlinear
Element Types Used:	Coupled-Field SOLID98
ANSYS Features Demonstrated:	importing an IGES model, SmartSizing, selecting entities, applying voltage, temperature, and displacement boundary conditions, plotting voltage, temperature, and displacement results, animating displacement results, listing heat flow and current
Applicable Help Available:	Coupled-Field Analysis and Direct Coupled-Field Analysis in the <i>Coupled-Field Analysis Guide</i> , SOLID98 in the <i>Element Reference</i> .

5.1.2. Problem Description

This tutorial demonstrates how to analyze an electrical-thermal actuator used in a micro-electromechanical system (MEMS). The thermal actuator is fabricated from polysilicon and is shown below.

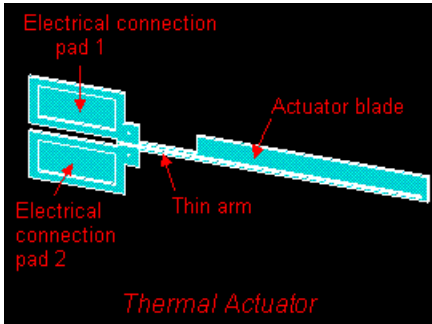

The thermal actuator works on the basis of a differential thermal expansion between the thin arm and blade.

The required analysis is a coupled-field multiphysics analysis that accounts for the interaction (coupling) between thermal, electric, and structural fields.

A potential difference applied across the electrical connection pads induces a current to flow through the arm and blade. The current flow and the resistivity of the polysilicon produce Joule heating (I^2R) in the arm and blade. The Joule heating causes the arm and the blade to heat up. Temperatures in the range of 700 -1300 °K are generated. These temperatures produce thermal strain and thermally induced deflections.

The resistance in the thin arm is greater than the resistance in the blade. Therefore, the thin arm heats up more than the blade, which causes the actuator to bend towards the blade. The maximum deformation occurs at the actuator tip. The amount of tip deflection (or force applied if the tip is restrained) is a direct function of the applied potential difference. Therefore, the amount of tip deflection (or applied force) can be accurately calibrated as a function of applied voltage.

These thermal actuators are used to move micro devices, such as ratchets and gear trains. Arrays of thermal actuators can be connected together at their blade tips to multiply the effective force.

The main objective of the analysis is to compute the blade tip deflection for an applied potential difference across the electrical connection pads. Additional objectives are to:

- Obtain temperature, voltage, and displacement plots
- Animate displacement results
- Determine total current and heat flow.

5.1.2.1. Given

You are supplied with a solid model in an IGES file. Dimensions are in micrometers. The thermal actuator has an overall length of approximately 250 micrometers, and a thickness of 2 micrometers. The given potential difference across the electrical connection pads is 5 volts.

Material Properties for Polysilicon	
Young's modulus	169 GPa
Poisson's ratio	0.22
Resistivity	2.3e-5 ohm-m
Coefficient of thermal expansion	2.9e-6/°K
Thermal conductivity	150 W/m°K

5.1.2.2. Approach and Assumptions

Coupled-field problems can be solved using the direct method or the sequential method. The direct method performs the coupled-field analysis in one step using coupled-field elements. The sequential method performs the coupled-field analysis in multiple steps, where the results from one step are used as input to the next step. Coupled field elements are not required for the sequential method.

This tutorial uses the direct method to evaluate the actuator. The direct approach is the most efficient method for this problem. However, if it were necessary to include the effects of temperature-dependent material properties and/or thermal radiation, it would probably be more efficient to use the sequential method. The nonlinear thermal-electric problem could be solved using [SOLID98](#) elements with only the TEMP and VOLT degrees of freedom active, and the mechanical problem could be solved using [SOLID92](#) elements. The temperatures calculated in the thermal analysis could be applied as loading to the mechanical model using the [LDREAD](#) command.

For this problem, you first import the file **actuator.iges** into ANSYS. Next, you define the element type as [SOLID98](#) using the default degrees of freedom [KEYOPT(1)]: UX, UY, UZ, TEMP, VOLT, MAG. The element simulates the coupled thermal-electric-structural response. The MAG degree of freedom is not required for this analysis so you will not assign a magnetic material property.

To define material properties for this analysis, you must convert the given units for Young's modulus, resistivity, and thermal conductivity to μMKS units. The units have been converted to μMKS for you, and are shown in the following table.

Material Properties for Polysilicon (μMKS units)	
Young's modulus	169e3 MPa
Poisson's ratio	0.22
Resistivity	2.3e-11 ohm- μm
Coefficient of thermal expansion	2.9e-6/ $^{\circ}\text{K}$
Thermal conductivity	150e6 pW/ $\mu\text{m}^{\circ}\text{K}$

Next, you mesh the model with the coupled field elements. You then apply voltages to the electrical connection pads and set their temperature to an assumed 30 $^{\circ}\text{C}$. You then mechanically fix the electrical connection pads in the X, Y, and Z directions.

Finally, you obtain the solution and post process the results to achieve the analysis objectives, as stated above.

5.1.2.3. Summary of Steps

Use the information in the problem description and the steps below as a guideline in solving the problem on your own. Or, use the detailed interactive step-by-step solution by choosing the link for step 1.

Import Geometry

1. [Import IGES file.](#)

Define Materials

2. [Define element type.](#)

3. Define material properties.

Generate Mesh

4. Mesh the model.

Apply Loads

5. Plot areas.
6. Apply boundary conditions to electrical connection pad 1.
7. Apply boundary conditions to electrical connection pad 2.

Obtain Solution

8. Solve.

Review Results

9. Plot temperature results.
10. Plot voltage results.
11. Plot displacement results and animate.
12. List total heat flow and current.
13. Exit the ANSYS program.

5.1.3. Import Geometry

5.1.3.1. Step 1: Import IGES file.

You will begin by importing the model of the actuator. It is provided for you in the form of an IGES file.

1. **Utility Menu> File> Import> IGES**
2. "No defeaturing"
3. [OK]
4. File name: **actuator.iges**

UNIX version:

```
/ansys_inc/v121/ansys/data/models/actuator.iges
```

PC version:

```
\Program Files\Ansys Inc\V121\ANSYS\data\models\actuator.iges
```

5. [OK]

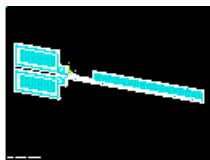

Note

If the model does not import, and a "Fatal error" message appears stating that more scratch space is needed, you will need to restart ANSYS, and, on the Interactive tab (UNIX version), or in the Interactive dialog box (PC version), change the memory settings to Total Workspace = 120 MB and Database = 32 MB.

5.1.4. Define Materials

5.1.4.1. Step 2: Define element type.

You will now specify the **element type** as coupled-field element **SOLID98**, and the default degrees of freedom [KEYOPT(1) = 0]: UX, UY, UZ, TEMP, VOLT, MAG. This problem makes use of all but the MAG degree of freedom.

1. **Main Menu > Preprocessor > Element Type > Add/Edit/Delete**
2. [Add ...]
3. "Coupled Field" (left column)
4. "Scalar Tet 98" (right column)
5. [OK]
6. [Close]

5.1.4.2. Step 3: Define material properties.

You will now enter the **material property** values for polysilicon. These values are for Young's modulus, Poisson's ratio, thermal expansion coefficient, thermal conductivity, and resistivity. The units for these values are μMKSV .

1. **Main Menu > Preprocessor > Material Props > Material Models**
2. (double-click) "Structural," then "Linear," then "Elastic," then "Isotropic"
3. "EX" = 169e3
4. "PRXY" = 0.22
5. [OK]
6. (double-click) "Thermal Expansion," then "Secant Coefficient," then "Isotropic"
7. "ALPX" = 2.9e-6
8. [OK]
9. (double-click) "Thermal," then "Conductivity," then "Isotropic"
10. "KXX" = 150e6
11. [OK]
12. (double-click) "Electromagnetics," then "Resistivity," then "Constant"

13. "RSVX" = 2.3e-11
14. [OK]
15. **Material> Exit**

5.1.5. Generate Mesh

5.1.5.1. Step 4: Mesh the model.

You will now obtain a course volume mesh using tetrahedral shapes. Setting the SmartSizing control to 10 (maximum) achieves the course mesh.

1. **Main Menu> Preprocessor> Meshing> MeshTool**
2. (check) "SmartSize"
3. (slide) "Course" = "10"
4. [Mesh]
5. [Pick All]

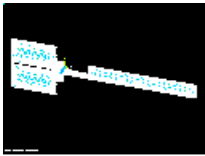

6. [Close] MeshTool

5.1.6. Apply Loads

5.1.6.1. Step 5: Plot areas.

You will now plot individual areas in preparation for when you apply the boundary conditions to the electrical connection pads, which you will do in the next two steps. You will first set ANSYS to display each of the areas in a distinguishing color and number.

1. **Utility Menu> PlotCtrls> Numbering**
2. (check) "Area numbers" to "On"
3. [OK]
4. **Utility Menu> Plot> Areas**

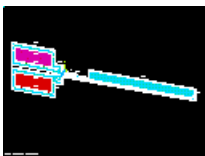

5.1.6.2. Step 6: Apply boundary conditions to electrical connection pad 1.

You will now apply the voltage, temperature, and displacement boundary conditions to electrical connection pad 1. You will first select this pad area so you only have to perform the picking function once there, even though you are applying three different types of boundary conditions.

1. **Utility Menu> Select> Entities**

2. (first drop down) "Areas"
3. (second drop down) "By Num/Pick"
4. [OK]
5. Pick electrical connection pad 1 (the upper pad). Ensure that you have picked the correct area by holding the mouse button down and dragging the mouse until ONLY the pad area highlights, then release the button.

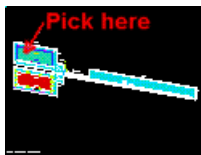

6. [OK]

Now apply the voltage boundary condition to pad 1.

7. **Main Menu > Preprocessor > Loads > Define Loads > Apply > Electric > Boundary > Voltage > On Areas**
8. [Pick All]

By choosing Pick All, you pick only the area representing pad 1 because that is the only entity you currently have selected.

9. "Load VOLT Value" = 5
10. [OK]

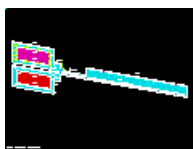

Notice the voltage boundary condition symbols added to pad 1.

Now apply the temperature boundary condition to pad 1.

11. **Main Menu > Preprocessor > Loads > Define Loads > Apply > Thermal > Temperature > On Areas**
12. [Pick All]
13. "DOF to be constrained" = TEMP
14. "Load TEMP value" = 30
15. [OK]

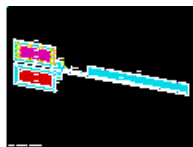

Notice the temperature boundary condition symbols added to pad 1.

Now apply the displacement boundary conditions to pad 1.

16. **Main Menu > Preprocessor > Loads > Define Loads > Apply > Structural > Displacement > On Areas**

17. [Pick All]
18. "DOFs to be constrained" = UX
19. "Displacement value" = 0
20. [Apply]
21. [Pick All]
22. "DOFs to be constrained" = UY
23. [Apply]
24. [Pick All]
25. "DOFs to be constrained" = UZ
26. [OK]

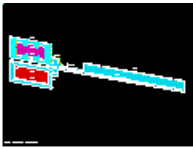

Notice that ANSYS cumulatively added the displacement boundary condition symbols to the pad after you applied them (i.e., X constraint, then Y constraint, then Z constraint).

5.1.6.3. Step 7: Apply boundary conditions to electrical connection pad 2.

You will now apply the voltage, temperature, and displacement boundary conditions to electrical connection pad 2. The procedure you follow is identical to the one you just performed to add boundary conditions to pad 1.

1. **Utility Menu> Select> Entities**
2. (first drop down) "Areas"
3. (second drop down) "By Num/Pick"
4. [OK]
5. Pick electrical connection pad 2 (the lower pad). Ensure that you have picked the correct area by holding the mouse button down and dragging the mouse until ONLY the pad area highlights, then release the button.



6. [OK]

Now apply the voltage boundary condition to pad 2.

7. **Main Menu> Preprocessor> Loads> Define Loads> Apply> Electric> Boundary> Voltage> On Areas**
8. [Pick All]

By choosing Pick All, you pick only the area representing pad 2 because that is the only entity you currently have selected.

9. "Load VOLT Value" = 0
10. [OK]

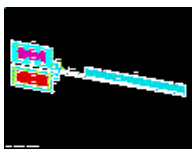

Notice the voltage boundary condition symbols added to pad 2.

Now apply the temperature boundary condition to pad 2.

11. **Main Menu> Preprocessor> Loads> Define Loads> Apply> Thermal> Temperature> On Areas**
12. [Pick All]
13. "DOF to be constrained" = TEMP
14. "Load TEMP Value" = 30
15. [OK]

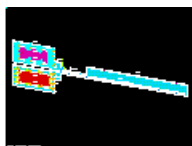

Notice the temperature boundary condition symbols added to pad 2.

Now apply the displacement boundary conditions to pad 2.

16. **Main Menu> Preprocessor> Loads> Define Loads> Apply> Structural> Displacement> On Areas**
17. [Pick All]
18. "DOFs to be constrained" = UX
19. "Displacement value" = 0
20. [Apply]
21. [Pick All]
22. "DOFs to be constrained" = UY
23. [Apply]
24. [Pick All]
25. "DOFs to be constrained" = UZ
26. [OK]

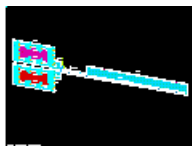

Notice that ANSYS cumulatively added the displacement boundary condition symbols to the pad after you applied them (i.e., X constraint, then Y constraint, then Z constraint).

Before solving the problem, you must select the entire finite element model.

27. **Utility Menu> Select> Everything**

5.1.7. Obtain Solution

5.1.7.1. Step 8: Solve.

You will now initiate the ANSYS solution.

1. **Main Menu> Solution> Solve> Current LS**
2. Review the information in the status window, then choose:

File> Close (Windows platforms),

or

Close (UNIX platforms), after reviewing the information in the status window.

3. [OK]
4. [Yes] to warning message.

This message is not relevant to this problem since you are not using the MAG DOF.

5. [Close] the information window when the solution is done.

5.1.8. Review Results

5.1.8.1. Step 9: Plot temperature results.

You will now plot the temperature results. This is one of the objectives of this analysis.

1. **Main Menu> General Postproc> Read Results> Last Set**
2. **Main Menu> General Postproc> PlotResults> Contour Plot> Nodal Solu**
3. "DOF solution"
4. "Temperature"
5. [OK]

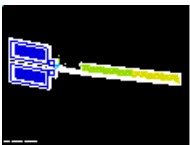

Refer to the legend beneath your plot for a numerical interpretation of the colors in the plot. Note that the electrical connection pads are the same color, reflecting the constant temperature boundary condition. Note also that there is a change in color in the blade, as viewed from the pads end to the blade tip end, indicating that the voltage difference across the pads causes a temperature difference across the blade. Note that the thin arm is at higher temperatures than the blade.

5.1.8.2. Step 10: Plot voltage results.

You will now plot the voltage results. This is one of the objectives of this analysis.

1. **Main Menu> General Postproc> Plot Results> Contour Plot> Nodal Solu**
2. "DOF solution"
3. "Electric potential"
4. [OK]

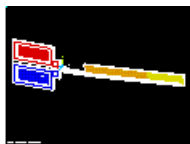

Refer to the legend beneath your plot for a numerical interpretation of the colors in the plot. Note that the electrical connection pads are distinctly two different colors, reflecting the voltage difference across the pads. Note also that there is a change in color in the blade, as viewed from the pads end to the blade tip end, indicating that the voltage drop from pad 1 to pad 2 is distributed along the electrical conduction path of the actuator.

5.1.8.3. Step 11: Plot displacement results and animate.

You will now plot and animate the displacement results. These are two of the objectives of this analysis.

1. **Main Menu> General Postproc> PlotResults> Contour Plot> Nodal Solu**
2. "DOF solution"
3. "Y-Component of displacement"
4. [OK]

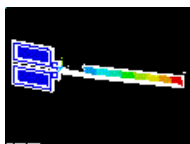

Refer to the legend beneath your plot for a numerical interpretation of the colors in the plot. Note that the electrical connection pads are the same color, reflecting that the pads are constrained in all directions. Note especially the gradual change in color in the blade and thin arm, as viewed from the pads end to the blade tip end. This display, along with the animation you will produce next, clearly show the bending of the thermal actuator.

Note also from the legend that the color of the tip of the blade indicates a deflection of approximately 3.07 micrometers. This deflection results from the 5 volts applied across the pads. You have just achieved the main objective of this analysis.

You will now produce the corresponding animation.

5. **Utility Menu> PlotCtrls> Animate> Deformed Results**
6. (left column) "DOF solution"
7. (right column) "Translation UY"
8. [OK]

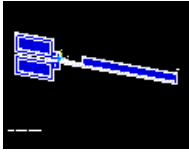

9. [Close] after making desired choices in the Animation Controller.

5.1.8.4. Step 12: List total heat flow and current.

You will now obtain a listing of results including the total heat flow and current. These are two of the objectives for this analysis.

1. **Utility Menu> Plot> Areas**
2. **Utility Menu> Select> Entities**
3. (first drop down) "Areas"
4. (second drop down) "By Num/Pick"
5. [OK]
6. Pick the electrical connection pad on the thin side of the actuator (lower pad as shown below).



7. [OK]
8. **Utility Menu> Select> Entities**
9. (first drop down) "Nodes"
10. (second drop down) "Attached to"
11. "Areas, all"
12. [OK]
13. **Utility Menu> List> Results> Reaction Solution**
14. "1st 10 items"
15. [OK]

Scroll to the bottom of the list and note that the total heat flow is approximately 8.07e9 pW and the total current is approximately 3.23e9 pA.

16. When you are done viewing the listing, choose:

File> Close (Windows platforms),

or

Close (UNIX platforms)

17. **Utility Menu> Select> Everything**

5.1.8.5. Step 13: Exit the ANSYS program.

1. Toolbar: **Quit**

2. "Quit - No Save!"
3. [OK]

Congratulations! You have completed this tutorial.

Even though you have exited the ANSYS program, you can still view animations [using the ANSYS ANIMATE program](#). The ANIMATE program runs only on the PC and is extremely useful for:

- Viewing ANSYS animations on a PC regardless of whether the files were created on a PC (AVI files) or on a UNIX workstation (ANIM files).
- Converting ANIM files to AVI files.
- Sending animations over the web.

Chapter 6: Explicit Dynamics Tutorial

Drop Test of a Container

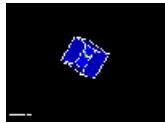

- Problem Specification
- Problem Description
- Define Analysis Type
- Input Geometry
- Define Element Type, Real Constants, Material Model Properties
- Generate Mesh
- Apply Loads
- Obtain Solution
- Review Results

6.1. Drop Test of a Container (Explicit Dynamics)

6.1.1. Problem Specification

Applicable ANSYS Products:	ANSYS LS-DYNA, ANSYS ED
Level of Difficulty:	moderate
Interactive Time Required:	60 to 90 minutes
Discipline:	structural
Analysis Type:	transient dynamics (explicit method)
Element Types Used:	SHELL163
ANSYS Features Demonstrated:	direct generation of nodes and elements, array parameters, automatic meshing, animation
Applicable Help Available:	The <i>ANSYS LS-DYNA User's Guide</i> , SHELL163 in the <i>Element Reference</i> .

6.1.2. Problem Description

This is a dynamic analysis of dropping an aluminum container on a steel table top. As shown below, the container is a five-sided square box, 20 inches on all sides and 0.1 inches thick. It has been rotated 45° about each of the X, Y, and Z axes. The table top is a square steel plate 100 inches on each side and 0.1 inches thick. The only force acting on the box is its own weight. It is dropped from a distance of 72 inches. The

problem is typical of a drop test. The objective of the problem is to demonstrate the explicit dynamics capabilities of ANSYS LS-DYNA -- ideal for large deformation and complex contact dynamic problems.

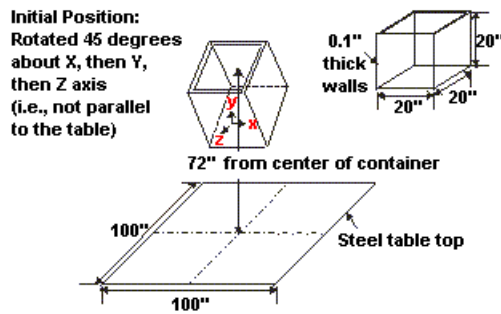

6.1.2.1. Given

The dimensions of the container and table top are shown above. The container is made of aluminum alloy with Young's modulus of 10.3E6 psi, density of 2.5E-4 lb_f-sec²/in⁴, Poisson's ratio of 0.334, Yield Stress of 5,000 psi, and a tangent modulus of 20,000 psi. The table top is made of carbon steel with Young's modulus of 30.0E6 psi, density of 7.3E-4 lb_f-sec²/in⁴, and Poisson's ratio of 0.292.

6.1.2.2. Approach and Assumptions

During the free fall stage, the container is simply accelerating due to gravity. To save CPU time, start the analysis at 20 inches above the table top and apply an initial velocity of 200 inches per second to simulate the first 52 inches of free fall. 200 inches per second is an approximation derived using $V_f = \text{SQRT}(2*a*s)$ where V_f is the final velocity, a is the acceleration due to gravity, and s is the displacement. Friction from the air is neglected.

Assume a rigid behavior for the table top and bilinear kinematic hardening von Mises plasticity for the container.

Solid modeling is used to generate the 3-D model of the container, which then will be meshed. Direct generation of nodes and elements will be used to model the table top. The table top will be modeled as a rigid element and only one element will be used to represent it.

6.1.2.3. Summary of Steps

Use the information in the problem description and the steps below as a guideline in solving the problem on your own. Or, use the detailed interactive step-by-step solution by choosing the link for step 1.

Define Analysis Type

1. Set preferences.

Input Geometry

2. Read in geometry of the container.

Define Element Type, Real Constants, Material Model Properties

3. Define element type.
4. Define real constants.

5. Specify material models.

Generate Mesh

6. Mesh the container.

7. Generate table top elements.

8. Create container component.

9. Create table top component.

10. Specify contact parameters.

Apply Loads

11. Apply initial velocity to the container.

12. Apply acceleration to the container.

Obtain Solution

13. Specify Output Controls.

14. Solve.

Review Results

15. Animate stress contours.

16. Animate deformed shape.

17. Exit the ANSYS program.

6.1.3. Define Analysis Type

6.1.3.1. Step 1: Set Preferences.

You will first set preferences in order to filter quantities that pertain to this discipline only.

1. **Main Menu> Preferences**
2. (check) "Individual discipline(s) to show in the GUI" = Structural
3. (check) "Discipline options" = LS-DYNA Explicit
4. [OK]

6.1.4. Input Geometry

6.1.4.1. Step 2: Read in geometry of the container.

You will begin by reading in a file that includes the model of the container.

1. **Utility Menu> File> Read Input from ...**
2. File name: `container.inp`

UNIX version:

```
/ansys_inc/v121/ansys/data/models/container.inp
```

PC version:

```
\Program Files\Ansys Inc\V121\ANSYS\data\models\container.inp
```

3. [OK]

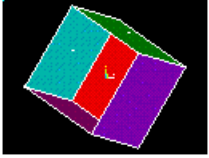

6.1.5. Define Element Type, Real Constants, Material Model Properties

6.1.5.1. Step 3: Define element type.

Since the model is a container made of thin walls hitting the surface of a table, shell elements will be used to simulate the physical model. More precisely, [SHELL163](#), an explicit thin structural shell, is the element of choice. This 4-node element can take both in-plane and normal loads.

1. **Main Menu > Preprocessor > Element Type > Add/Edit/Delete**
2. [Add...]
3. "LS-DYNA Explicit" (left column)
4. "Thin Shell 163" (right column)
5. [OK]

Now, specify the S/R corotational Hughes-Liu element formulation to eliminate certain hourglass modes.

6. [Options...]
7. (drop down) "Element Formulation" = S/R corotation
8. [OK]
9. [Close]

6.1.5.2. Step 4: Define real constants.

Next, define the thickness of the shell elements by defining the appropriate real constant.

1. **Main Menu > Preprocessor > Real Constants**
2. [Add...]
3. [OK] to choose element Type 1 for [SHELL163](#).
4. [OK] to define real constant set No. 1.
5. "SHRF" = 1
6. "NIP" = 2 (For demonstration purposes in this tutorial, the default value of 2 is sufficient. However, for most nonlinear analyses, the NIP should be set higher than 2.)
7. "T1" = 0.1

8. "T2" = 0.1
9. "T3" = 0.1
10. "T4" = 0.1
11. "NLOC" = Mid surface
12. [OK]
13. [Close]

6.1.5.3. Step 5: Specify material models.

Now specify material models for the contact and target surfaces.

1. **Main Menu> Preprocessor> Material Props> Material Models**
2. (double-click) "LS-DYNA", then "Rigid Material" to specify the table top, which is "Material Model Number 1"
3. "DENS" = 7.3e-4
4. "EX" = 30e6
5. "NUXY" = 0.292
6. (drop down) "Translational Constraint Parameter" = All disps.
7. (drop down) "Rotational Constraint Parameter" = All rotations
8. [OK]
9. **Material> New Model** to specify the material for the container, which is "Material Model Number 2"
10. "Define Material ID" = 2
11. [OK]
12. (double-click) "Nonlinear", then "Inelastic", then "Kinematic Hardening", then "Bilinear Kinematic"
13. "DENS" = 2.5e-4
14. "EX" = 10.3e6
15. "NUXY" = 0.334
16. "Yield Stress" = 5000
17. "Tangent Modulus" = 20000
18. [OK]
19. **Material> Exit**
20. Toolbar: **SAVE_DB**

6.1.6. Generate Mesh

6.1.6.1. Step 6: Mesh the container.

In an explicit solver, such as ANSYS LS-DYNA, the analysis time is highly dependent on the smallest element in the model. Therefore, for efficient results, a uniform element size should be used.

For this example, use the default element size. This should give a 3x3 mesh on each face of the container.

1. **Main Menu> Preprocessor> Meshing> MeshTool**

2. (drop down) "Element Attributes" = Global; then [Set]
3. (drop down) "Material number" = 2
4. [OK]
5. (drop down) "Mesh" = Areas
6. (check) "Mapped"
7. [Mesh]
8. [Pick All]

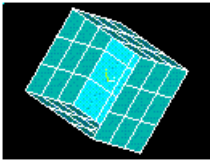

9. Toolbar: **SAVE_DB**

6.1.6.2. Step 7: Generate table top elements.

Now mesh the table top by [direct element generation](#). The table top will be defined as a rigid surface and therefore only one element is needed to model this surface. Create this model by defining its four corner nodes and then building the elements from those nodes.

1. **Utility Menu> PlotCtrls> Pan, Zoom, Rotate**
2. [Obliq]
3. [Close]
4. **Utility Menu> PlotCtrls> Numbering**
5. (check) "Node numbers" = On
6. [OK]

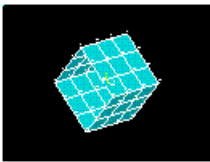

7. (drop down in MeshTool) "Element Attributes" = Global; then [Set]
8. (drop down) "Material number" = 1
9. [OK]
10. [Close] MeshTool
11. **Main Menu> Preprocessor> Modeling> Create> Nodes> In Active CS**
12. "Node number" = Leave blank so it defaults to the next available node number.
13. "X Y Z Location in active CS" = -50, -20, -50
14. [Apply] to generate the node in the far left corner.
15. "X Y Z Location in active CS" = -50, -20, 50
16. [Apply] to generate the node in the near left corner.
17. "X Y Z Location in active CS" = 50, -20, 50

18. [Apply] to generate the node in the near right corner.
19. "X Y Z Location in active CS" = 50, -20, -50
20. [OK] to generate the node in the far right corner.

Now create the element.

21. **Main Menu > Preprocessor > Modeling > Create > Elements > Auto Numbered > Thru Nodes**
22. In a counterclockwise direction, pick the four nodes just created.



23. [OK]
24. **Utility Menu > Plot > Elements**

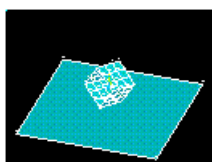

6.1.6.3. Step 8: Create container component.

Most of the contact algorithms require contact parameters, which can be components, part IDs, or part assembly IDs. For this tutorial, create a component made of nodes from the container.

1. **Utility Menu > Select > Entities**
2. (first drop down) "Elements"
3. (second drop down) "By Attributes"
4. (check) "Material num"
5. "Min,Max,Inc." = 2
6. [Apply]
7. (first drop down) "Nodes"
8. (second drop down) "Attached to"
9. (check) "Elements"
10. [OK]
11. **Utility Menu > Select > Comp/Assembly > Create Component**
12. "Component name" = BOX
13. (drop down) "Component is made of" = Nodes
14. [OK]
15. **Utility Menu > Plot > Nodes**

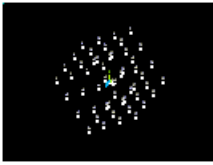

16. **Utility Menu> Select> Everything**

6.1.6.4. Step 9: Create table top component.

Now, create a component made of nodes from the table top.

1. **Utility Menu> Select> Entities**
2. (first drop down) "Elements"
3. (second drop down) "By Attributes"
4. (check) "Material num"
5. "Min,Max,Inc" = 1
6. [Apply]
7. (first drop down) "Nodes"
8. (second drop down) "Attached to"
9. (check) "Elements"
10. [OK]
11. **Utility Menu> Select> Comp/Assembly> Create Component**
12. "Component name" = TABLE
13. (drop down) "Component is made of" = Nodes
14. [OK]
15. **Utility Menu> Plot> Nodes**



16. **Utility Menu> Select> Everything**
17. Toolbar: **SAVE_DB**

6.1.6.5. Step 10: Specify contact parameters.

In an analysis in which the contact behavior is known, the appropriate contact algorithm can be chosen for the best results. However, due to the nature of this problem, contact conditions will be unpredictable. Thus, by choosing automatic surface to surface contact, the program will automatically adjust for the changes which occur during this simulation.

1. **Main Menu> Preprocessor> LS-DYNA Options> Contact> Define Contact**
2. "Contact Type" = "Surface to Surf" (left column); "Automatic (ASTS)" (right column)
3. [OK]

4. (drop down) "Contact Component or Part no." = BOX
5. (drop down) "Target Component or Part no." = TABLE
6. [OK]
7. Toolbar: **SAVE_DB**

6.1.7. Apply Loads

6.1.7.1. Step 11: Apply initial velocity to the container.

1. **Main Menu> Solution> Initial Velocity> On Nodes> w/Nodal Rotate**
2. (drop down) "Input velocity on component" = BOX
3. "Global (Translational) Y-component" = -200
4. [OK]

In a transient dynamic analysis, loads must be defined for the duration of the analysis. To do so, create an array containing this data.

5. **Utility Menu> Parameters> Array Parameters> Define/Edit**
6. [Add...]
7. "Parameter name" = TIME
8. [OK]
9. [Edit...]
10. "1" = 0
11. "2" = 1
12. **File> Apply/Quit**
13. [Add...]
14. "Parameter name" = ACCG
15. [OK]
16. (highlight) "ACCG"
17. [Edit...]
18. "1" = 386.4
19. "2" = 386.4
20. **File> Apply/Quit**
21. [Close]

6.1.7.2. Step 12: Apply acceleration to the container.

1. **Main Menu> Solution> Loading Options> Specify Loads**
2. "Load Labels" = ACLY
3. (drop down) "Component name or PART number:" = BOX
4. (drop down) "Parameter name for time values:" = TIME
5. (drop down) "Parameter name for data values:" = ACCG

6. [OK]

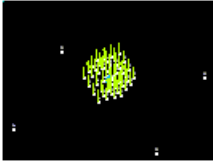

6.1.8. Obtain Solution

6.1.8.1. Step 13: Specify output controls.

1. **Main Menu> Solution> Time Controls> Solution Time**
2. "Terminate at Time:" = 1.0
3. [OK]
4. **Main Menu> Solution> Output Controls> File Output Freq> Number of Steps**
5. "Specify Results File Output Interval" = 50
6. "Specify Time History Output Interval" = 50
7. [OK]
8. **Main Menu> Solution> Analysis Options> Energy Options**
9. [OK] to turn on all energy options
10. Toolbar: **SAVE_DB**

6.1.8.2. Step 14: Solve.

1. **Main Menu> Solution> Solve**
2. Review the information in the status window, then choose:

File> Close (Windows) or

Close (X11/Motif), to close the window.

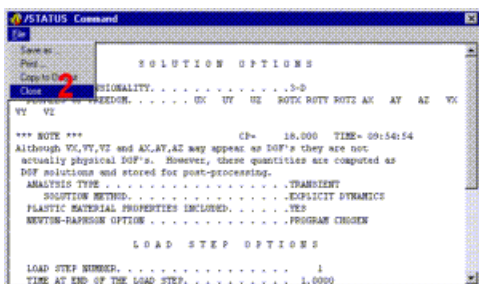

3. [OK] to initiate solution.

Note: A verification window will appear to notify you of a warning message. This warning was generated due to constraining the table top by defining it as a rigid element rather than using degrees of freedom constraints. Therefore the warning can be ignored.

4. [Yes]
5. [Close]

6.1.9. Review Results

6.1.9.1. Step 15: Animate stress contours.

1. **Utility Menu> Plot> Elements**
2. **Utility Menu> PlotCtrls> Pan, Zoom, Rotate**
3. [Front]
4. [Close]
5. **Utility Menu> PlotCtrls> Numbering**
6. (check) "Node numbers" = Off
7. [OK]

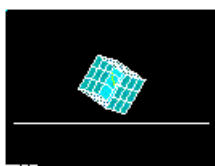

8. **Main Menu> General Postproc> Read Results> First set**

[Note for UNIX systems only: To capture the animation sequence in terminal segment memory, it is necessary to reduce the size of the Graphics Window or you will run out of terminal memory. Although this depends on your particular system, and the size of the animation file to be created, for this exercise it is suggested that the ratio of the original window size to the reduced window size should be about 3:1.]

9. **Utility Menu> PlotCtrls> Animate> Over Results**
10. (check) "Auto contour scaling" = On (Make sure that the box is checked.)
11. "Contour data for animation" = Stress (left column); von Mises SEQV (right column)
12. [OK]

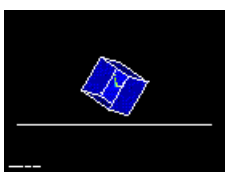

13. Make choices in the Animation Controller (not shown), if necessary, then [Close].

6.1.9.2. Step 16: Animate deformed shape.

1. **Utility Menu> PlotCtrls> Animate> Over Results**
2. (check) "Auto contour scaling" = On
3. "Contour data for animation" = DOF Solution (left column); Deformed Shape (right column)
4. [OK]

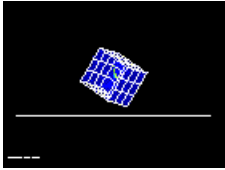

5. Make choices in the Animation Controller (not shown), if necessary, then [Close].

6.1.9.3. Step 17: Exit the ANSYS program.

1. Toolbar: **Quit**
2. (check) "Quit - No Save!"
3. [OK]

Congratulations! You have completed this tutorial.

Even though you have exited the ANSYS program, you can still view animations [using the ANSYS ANIMATE program](#). The ANIMATE program runs only on the PC and is extremely useful for:

- Viewing ANSYS animations on a PC regardless of whether the files were created on a PC (AVI files) or on a UNIX workstation (ANIM files).
- Converting ANIM files to AVI files.
- Sending animations over the web.

Chapter 7: Contact Tutorial

Interference Fit and Pin Pull-Out Contact Analysis

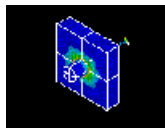

- Problem Specification
- Problem Description
- Input Geometry
- Define Material Property and Element Type
- Generate Mesh
- Specify Solution Criteria
- Load Step 1
- Load Step 2
- Postprocessing

7.1. Interference Fit and Pin Pull-Out Contact Analysis

7.1.1. Problem Specification

Applicable ANSYS Products:	ANSYS Multiphysics, ANSYS Mechanical, ANSYS Structural, ANSYS ED
Level of Difficulty:	moderate
Interactive Time Required:	45 to 60 minutes (includes 15 to 20 minutes for solution)
Discipline:	structural
Analysis Type:	nonlinear quasi-static
Element Types Used:	SOLID185, TARGE170, CONTA174
ANSYS Features Demonstrated:	symmetry boundary conditions, flexible-to-flexible surface contact, contact wizard, automatic time stepping, multiple load steps, symmetry expansion, animation, time history postprocessing, Solution Controls dialog box
Applicable Help Available:	The <i>Contact Technology Guide</i> , SOLID185, TARGE170, and CONTA174 in the <i>Element Reference</i> .

7.1.2. Problem Description

This is a 3-D analysis of a steel pin contacting a smooth pinhole in a block. Because of the inherent symmetry of the model, you will perform the analysis on a quarter symmetry model. You will define two different load steps. The objective of the first load step is to observe the interference fit stresses of the pin which is geometrically thicker than its pinhole. The objective of the second load step is to observe the stresses, contact pressures and reaction forces due to the motion of the pin being pulled out from the block.

7.1.2.1. Given

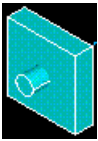

The dimensions of the model are as follows: PIN radius = 0.5 units, length = 2.5 units. BLOCK width = 4 units, length = 4 units, depth = 1 unit. PINHOLE radius = 0.49 units, depth = 1 unit. Both solids are made of structural steel (stiffness = 36e6, Poisson's ratio = 0.3) and are assumed to be flexible.

7.1.2.2. Approach and Assumptions

A quarter symmetry model is appropriate to simulate the contact phenomena. You will use two load steps to set up the analysis: Load Step 1: Interference Fit -- solve the problem with no additional displacement constraints. The pin is constrained within the pinhole due to its geometry. Stresses are generated due to the general misfit between the target (pinhole) and the contact (pin) surfaces. Load Step 2: Pull-out -- move the pin by 1.7 units out of the block using DOF displacement conditions on coupled nodes. Explicitly invoke Automatic Time Stepping to guarantee solution convergence. Read results for every 10th substep during solution.

7.1.2.3. Summary of Steps

Use the information in the problem description and the steps below as a guideline in solving the problem on your own. Or, use the detailed interactive step-by-step solution by choosing the link for step 1.

Note

To run this tutorial, you will need a total workspace memory of at least 64MB, preferably higher (100-200 MB). Before starting the tutorial, check your workspace memory as follows:

1. **Utility Menu > List > Status > Configuration**
2. Scroll down to the MEMORY STATISTICS heading and read the number of MB for Requested Initial Work Space.
3. If this number is acceptable, proceed with the tutorial. If the number is too low, quit ANSYS without saving changes, restart ANSYS and, in the ANSYS Interactive dialog box, enter the appropriate number in the Memory requested for Total Workspace field before choosing Run.

Input Geometry

1. [Read in the model of the pin and the block.](#)

Define Material Property and Element Type

2. Define material.
3. Define element type for solid volume.

Generate Mesh

4. Mesh solid volume.
5. Smooth element edges for graphics display.
6. Create contact pair using Contact Wizard.

Specify Solution Criteria

7. Apply symmetry constraints on (quartered) volume.
8. Define boundary constraints on block.
9. Specify a large displacement static analysis.

Load Step 1

10. Define interference fit analysis options.
11. Solve load step 1.

Load Step 2

12. Set DOF displacement for pin.
13. Define pull-out analysis options.
14. Write results to file.
15. Solve load step 2.

Postprocessing

16. Expand model from quarter symmetry to full volume.
17. Observe interference fit stress state.
18. Observe intermediate contact pressure on pin.
19. Observe pulled-out stress state.
20. Animate pin pull-out.
21. Plot reaction forces for pin pull-out.
22. Exit the ANSYS program.

7.1.3. Input Geometry

7.1.3.1. Step 1: Read in the model of the pin and block.

You will begin by reading in a file that includes a quarter symmetry representation of the pin and block.

1. **Utility Menu> File> Read Input from ...**

2. File name: `block.inp`

UNIX version:

```
/ansys_inc/v121/ansys/data/models/block.inp
```

PC version:

```
\Program Files\Ansys Inc\V121\ANSYS\data\models\block.inp
```

3. **OK**



7.1.4. Define Material Property and Element Type

7.1.4.1. Step 2: Define material.

You will now define the [material property](#).

1. **Main Menu> Preprocessor> Material Props> Material Models**
2. Double-click **Structural**, then **Linear, Elastic**, and **Isotropic**.
3. **EX = 36e6**
4. **PRXY = 0.3**.
5. Click **OK**.
6. Select **Material> Exit** from the menu bar.

7.1.4.2. Step 3: Define element types.

You will now define the [element type](#).

1. **Main Menu> Preprocessor> Element Type> Add/Edit/Delete**
2. Click **Add**.
3. Select **Structural Mass - Solid**.
4. Select **Brick 8node 185** (right column).
5. Click **OK**.
6. Click **Close**.

7.1.5. Generate Mesh

7.1.5.1. Step 4: Mesh solid volume.

1. **Main Menu> Preprocessor> Meshing> MeshTool**
2. Select **Lines - Set**.
3. Pick the horizontal and vertical lines on the front edge of the pin.

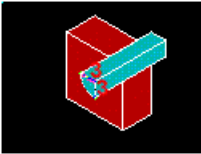

4. Click **OK**.
5. Enter 3 for **No. of element divisions**.
6. Uncheck **SIZE,NDIV can be changed** to indicate **No**.
7. Click **OK**.
8. Select **Lines - Set**.
9. Pick the curved line on the front of the block.



10. Click **OK**.
11. Enter 4 for **No. of element divisions**.
12. Click **OK**.
13. Select **Volumes** from the **Mesh** drop-down menu.
14. Select **Hex**.
15. Select **Sweep**.
16. Click the **Sweep** button.
17. Pick the pin and block volumes.

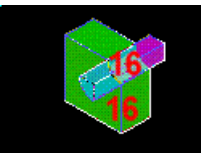

18. Click **OK** and **Close** any warning messages that appear.

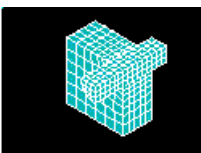

19. **Close** the MeshTool.

7.1.5.2. Step 5: Smooth element edges for graphics display.

1. **Utility Menu> PlotCtrls> Style> Size and Shape**
2. From the **Facets/element edge** drop-down menu, select **2 facets/edge**.
3. Click **OK**.

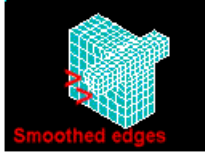

7.1.5.3. Step 6: Create contact pair using Contact Wizard.

1. **Main Menu> Preprocessor> Modeling> Create> Contact Pair**
2. Select the **Contact Wizard** button (located in the upper left corner of the Contact Manager).
3. Select **Areas** from the **Target Surface** field.
4. Select **Flexible** from the **Target Type** field.
5. Click **Pick Target**.
6. Pick surface of pin hole on block as the target.

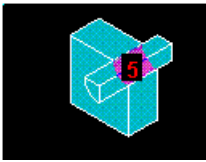

7. Click **OK**.
8. Click **Next**.
9. Select **Areas** from **Contact Surface** field.
10. Click **Pick Contact**.
11. Pick surface area of pin as the contact.

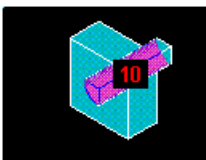

12. Click **OK**.
13. Click **Next**.
14. Select **Include Initial penetration**.
15. Select **1** from **Material ID** drop-down menu.
16. Enter **0.2** for the **Coefficient of friction**.
17. Click **Optional settings**.
18. Enter **0.1** for **Normal penalty stiffness**.
19. Select the **Friction** tab.

20. Select **Unsymmetric** from the **Stiffness matrix** drop-down menu.
21. Click **OK**.
22. Click **Create**.
23. Click **Finish** and close the Contact Manager.

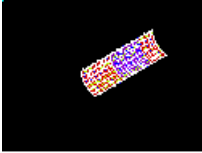

24. **Utility Menu> Plot> Areas**

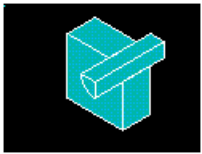

25. **Toolbar>SAVE_DB**.

7.1.6. Specify Solution Criteria

7.1.6.1. Step 7: Apply symmetry constraints on (quartered) volume.

1. **Main Menu> Solution> Define Loads> Apply> Structural> Displacement> Symmetry B. C.> On Areas**
2. Pick the four interior areas that were exposed when original model was quartered.

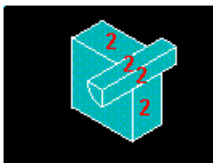

3. Click **OK**.

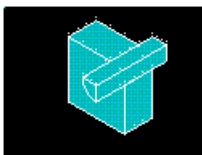

7.1.6.2. Step 8: Define boundary constraints on block.

1. **Main Menu> Solution> Define Loads> Apply> Structural> Displacement> On Areas**
2. Pick left side of block.

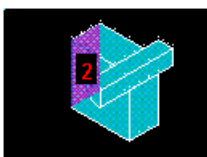

3. Click **OK**.

4. Select **All DOF** for **DOFs to be constrained**.
5. Enter 0 for the **Displacement value**.
6. Click **OK** to apply the constraints.

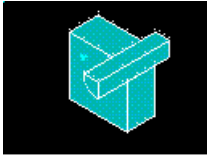

7.1.6.3. Step 9: Specify a large displacement static analysis.

In this step, you will specify the analysis option as a static analysis in which large deformation effects are to be included. To do this, you will use the Solution Controls dialog box, a central control panel where you can adjust the most commonly used settings for a structural static or full transient analysis. It consists of five tabbed "pages," each of which contains a set of related solution controls. You will use the Solution Controls dialog box again in this tutorial, to specify options for each of the load steps.

1. **Main Menu> Solution> Analysis Type> Sol'n Controls**
2. Select **Large Displacement Static** from the **Analysis Options** pull-down menu. Continue with the next step.

7.1.7. Load Step 1

7.1.7.1. Step 10: Define interference fit analysis options.

Note that for both load steps, ramped loading will automatically be applied instead of stepped loading. This is the default condition for a static analysis when the **SOLCONTROL** command is ON (which it is, also by default).

1. Enter 100 as the **Time at end of load step**.
2. Select **Off** from the **Automatic time stepping** drop-down menu.
3. Enter 1 as the **Number of substeps**.
4. Click **OK** to apply the settings.
5. **Toolbar>SAVE_DB**.

7.1.7.2. Step 11: Solve load step 1.

1. **Main Menu> Solution> Solve> Current LS**
2. Review the information in the status window, then **File> Close** to close the window.

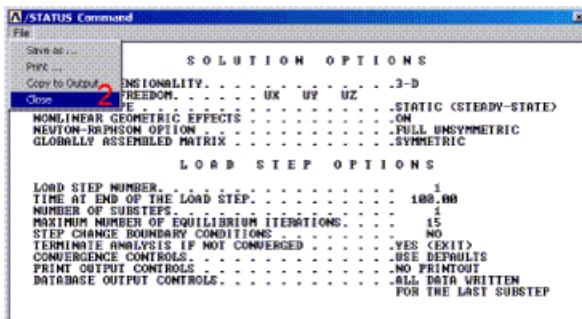

3. Click **OK** to begin the solution. Choose **Yes** if a Verify window appears, and ignore any warning messages, but do not close the warning message window yet.
4. **Close** the note window when solution is done.
5. **Utility Menu> Plot> Replot**. Continue with the next step.

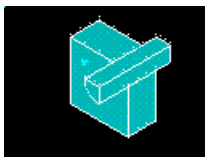

7.1.8. Load Step 2

7.1.8.1. Step 12: Set DOF displacement for pin.

You will now apply a displacement value of 1.7 to all nodes on the front of the pin in order to observe the effects of pulling the pin out of the block.

1. **Utility Menu> Select> Entities**
2. First drop down menu = **Nodes**.
3. Second drop-down menu = **By Location**.
4. Select **Z coordinates**.
5. Enter **4.5** for **Min, Max**.
6. Click **OK**.
7. **Main Menu> Solution> Define Loads> Apply> Structural> Displacement> On Nodes**
8. Click **Pick all**.
9. Select **UZ** for the **DOFs to be constrained**.
10. Enter a **Displacement value** of **1.7**.
11. Click **OK**.

7.1.8.2. Step 13: Define pull-out analysis options.

1. **Main Menu> Solution> Analysis Type> Sol'n Controls**
2. Enter **200** as the **Time at end of load step**.
3. Select **On** from the **Automatic time stepping** drop-down list.
4. Enter **100** for the **Number of substeps**.
5. Enter **10000** for the **Max no. of substeps**.
6. Enter **10** for the **Min no. of substeps**. Continue with the next step.

7.1.8.3. Step 14: Write results to file.

1. Select **Write every Nth substep** from the **Frequency** drop-down list.
2. Enter **-10** in the **where N equals (=)** field.
3. Click **OK**.
4. **Utility Menu> Select> Everything**

5. **Toolbar>SAVE_DB.****7.1.8.4. Step 15: Solve load step 2.**

ANSYS may produce several warning messages while solving this second load step. They will appear in a popup window and in the Output Window, but they will not prevent the solution from occurring. However, you should be aware that by default, ANSYS only displays the first 5 warning messages in the window. If more warning messages occur, which may be the case in the solution of this load step, they are not displayed, *nor is the "Solution is Done!" message displayed.*

To ensure that the "Solution is Done!" message appears, you are highly advised to change the setting that controls the number of messages that are displayed from 5 to 100. To do this, type the following in the Input Window, then press the **Enter** key:

```
/NERR,100,100,OFF
```

This also ensures that ANSYS will not abort if it encounters an error during solution.

You can then proceed with the following steps to obtain the solution.

1. **Main Menu> Solution> Solve> Current LS**
2. Review the information in the status window, then choose:

File> Close (Windows),

or

Close (X11/Motif), to close the window.

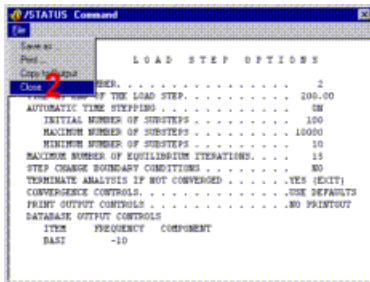

3. Click **OK** to begin the solution. Ignore any warning messages, but do not close the warning message window yet.
4. **Close** the note window when solution is done.

7.1.9. Postprocessing**7.1.9.1. Step 16: Expand model from quarter symmetry to full volume.**

1. **Utility Menu> PlotCtrls> Style> Symmetry Expansion> Periodic/Cyclic Symmetry**
2. Check **1/4 Dihedral Sym.**
3. Click **OK.**
4. **Utility Menu> Plot> Elements**



5. **Toolbar>SAVE_DB.**

7.1.9.2. Step 17: Observe interference fit stress state.

1. **Main Menu> General Postproc> Read Results> By Load Step**
2. Load step number = 1.
3. Click **OK.**
4. **Main Menu> General Postproc> Plot Results> Contour Plot> Nodal Solu**
5. Select **Stress** and then **von Mises stress.**
6. Click **OK.**

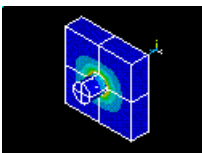

7.1.9.3. Step 18: Observe intermediate contact pressure on pin.

1. **Main Menu> General Postproc> Read Results> By Time/Freq**
2. Enter 120 as the **Value of time or freq.**
3. Click **OK.**
4. **Utility Menu> Select> Entities**
5. In the first drop-down list, select **Elements.**
6. In the second drop-down list, select **By Elem Name.**
7. Enter 174 as the **Element name.**
8. Click **OK.**
9. **Utility Menu> Plot> Elements**

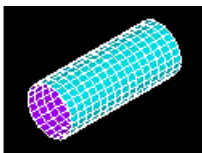

10. **Main Menu> General Postproc> Plot Results> Contour Plot> Nodal Solu**
11. Select **Contact.**
12. Select **Contact Pressure.**
13. Click **OK.**

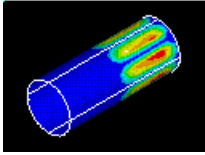

7.1.9.4. Step 19: Observe pulled-out stress state.

1. **Utility Menu> Select> Everything**
2. **Main Menu> General Postproc> Read Results> By Load Step**
3. Enter 2 as the **Load step number**.
4. Click **OK**.
5. **Main Menu> General Postproc> Plot Results> Contour Plot> Nodal Solu**
6. Select **Stress** and then **von Mises stress**.
7. Click **OK**.

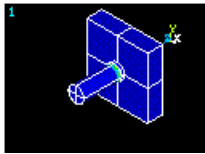

7.1.9.5. Step 20: Animate pin pull-out.

1. **Utility Menu> PlotCtrls> Animate> Over Results**
2. Select **Load Step Range** for the **Model result data**.
3. Check **Include last SBST for each LDST**.
4. Check **Auto contour scaling** (On).
5. (In the left column) **Contour data for animation = Stress**.
6. (In the right column) **Contour data for animation = von Mises SEQV**.
7. Click **OK**.

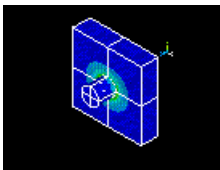

8. Make choices in the Animation Controller (not shown), if necessary, then **Close**.

7.1.9.6. Step 21: Plot reaction forces for pin pull-out.

1. **Utility Menu> List> Nodes**
2. Click **OK**.
3. Make note of all the node numbers whose Z coordinates are 4.5.

Your node numbers may be different from those shown here.

4. **File> Close** (Windows),

or

Close (X11/Motif), to close the window.

NODE	X	Y	Z	TRFX	TRFY	TRFZ
41	-0.13289	-0.33669	4.5000	0.00	0.00	0.00
42	-0.17497	-0.17454	4.5000	0.00	0.00	0.00
43	-0.48296	-0.12941	4.5000	0.00	0.00	0.00
44	-0.43361	-0.25000	4.5000	0.00	0.00	0.00
45	-0.33355	-0.33355	4.5000	0.00	0.00	0.00
46	-0.25000	-0.43361	4.5000	0.00	0.00	0.00
47	-0.12941	-0.48296	4.5000	0.00	0.00	0.00
48	-0.5513E-16	-0.50000	4.5000	0.00	0.00	0.00
49	-0.2775E-16	-0.18667	4.5000	0.00	0.00	0.00
50	-0.4163E-16	-0.33333	4.5000	0.00	0.00	0.00
51	-0.50000	0.61230E-16	4.5000	0.00	0.00	0.00
52	-0.16667	0.9442E-16	4.5000	0.00	0.00	0.00
53	-0.33333	0.7782E-16	4.5000	0.00	0.00	0.00
54	-0.1387E-16	0.1116E-15	4.5000	0.00	0.00	0.00
55	-0.56919	+0.22600	3.5000	0.00	0.00	0.00
56	-0.21703	-0.54062	3.5000	0.00	0.00	0.00
57	-1.1233	-0.33484	3.5000	0.00	0.00	0.00
58	-0.86071	-0.31518	3.5000	0.00	0.00	0.00
59	-0.66352	-0.26718	3.5000	0.00	0.00	0.00

5. **Utility Menu> Plot> Volumes**
6. **Main Menu> TimeHist Postproc**
7. Select **Add Data** (left most button).
8. Select **Reaction Forces, Structural Forces**, and then **Z-Component of Force**.
9. Click **OK**.
10. Pick a node on the front surface of the pin whose number corresponds to one of the nodes listed above for $z = 4.5$. (Hold down the left mouse button and drag the mouse cursor across the front of the pin. The highlighted node numbers appear in the picking menu. Upclick on the one you want to select.)
11. Click **OK**.
12. Verify that the node number you picked above is displayed in the Node number field.
Your node number may be different from the one shown here.
13. Click **Graph data** (third button from left) .
14. Close all **EXTREM Command** windows.
15. **File> Close** the **Time History Variables** window.

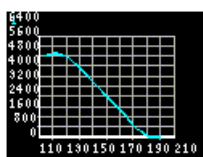

7.1.9.7. Step 22: Exit the ANSYS program.

1. Toolbar: **Quit**.
2. Select **Quit - No Save!**
3. Click **OK**.

Congratulations! You have completed this tutorial.

Even though you have exited the ANSYS program, you can still view animations [using the ANSYS ANIMATE program](#). The ANIMATE program runs only on the PC and is extremely useful for:

- Viewing ANSYS animations on a PC regardless of whether the files were created on a PC (AVI files) or on a UNIX workstation (ANIM files).

- Converting ANIM files to AVI files.
- Sending animations over the web.

Chapter 8: Modal Tutorial

Modal Analysis of a Model Airplane Wing

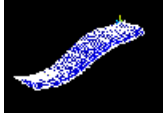

- Problem Specification
- Problem Description
- Input Geometry
- Define Material
- Generate Mesh
- Apply Loads
- Obtain Solution
- Review Results

8.1. Modal Analysis of a Model Airplane Wing

8.1.1. Problem Specification

Applicable ANSYS Products:	ANSYS Multiphysics, ANSYS Mechanical, ANSYS Structural, ANSYS ED
Level of Difficulty:	easy
Interactive Time Required:	30 to 45 minutes
Discipline:	structural
Analysis Type:	modal
Element Types Used:	PLANE42 and SOLID45
ANSYS Features Demonstrated:	extrusion with a mesh, selecting, eigenvalue modal analysis, animation
Applicable Help Available:	Modal Analysis in the <i>Structural Analysis Guide</i> , PLANE42 and SOLID45 in the <i>Element Reference</i> .

8.1.2. Problem Description

This is a simple modal analysis of a wing of a model airplane. The wing is of uniform configuration along its length and its cross-sectional area is defined to be a straight line and a spline as shown. It is held fixed to the body of the airplane on one end and hangs freely at the other. The objective of the problem is to find the wing's natural frequencies and mode shapes.

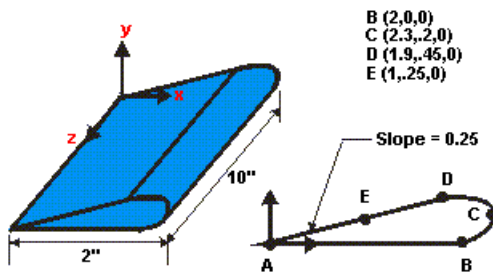

8.1.2.1. Given

The dimensions of the wing are as shown above. The wing is made of low density polyethylene with a Young's modulus of 38×10^3 psi, Poisson's ration of 0.3, and a density of 8.3×10^{-5} lb_f-sec²/in⁴.

8.1.2.2. Approach and Assumptions

Assume the side of the wing connected to the plane is completely fixed in all degrees of freedom. The wing is solid and material properties are constant and isotropic.

Solid modeling is used to generate a 2-D model of the cross-section of the wing. You then create a reasonable mesh and extrude the cross-section into a 3-D solid model which will automatically be meshed.

Additionally, the mesh used in this example will be fairly coarse for the element types used. This coarse mesh is used here so that this tutorial can be used with the ANSYS ED product.

8.1.2.3. Summary of Steps

Use the information in this description and the steps below as a guideline in solving the problem on your own. Or, use the detailed interactive step-by-step solution by choosing the link for step 1.

Input Geometry

1. Read in geometry input file.

Define Materials

2. Set preferences.
3. Define constant material properties.

Generate Mesh

4. Define element type.
5. Mesh the area.
6. Extrude the meshed area into a meshed volume.

Apply Loads

7. Unselect 2-D elements.
8. Apply constraints to the model.

Obtain Solution

9. Specify analysis types and options.
10. Solve.

Review Results

11. List the natural frequencies.
12. Animate the five mode shapes.
13. Exit the ANSYS program.

8.1.3. Input Geometry

8.1.3.1. Step 1: Read in geometry input file.

You will begin by reading in a file that includes the model.

1. **Utility Menu> File> Read Input from ...**
2. File name: wing.inp

UNIX version:

```
/ansys_inc/v121/ansys/data/models/wing.inp
```

PC version:

```
\Program Files\Ansys Inc\V121\ANSYS\data\models\wing.inp
```

3. [OK]

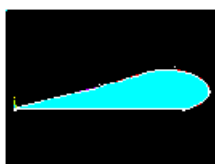

8.1.4. Define Materials

8.1.4.1. Step 2: Set preferences.

You will now set [preferences](#) in order to filter quantities that pertain to this discipline only.

1. **Main Menu> Preferences**
2. (check) "Structural"
3. [OK]

8.1.4.2. Step 3: Define constant material properties.

1. **Main Menu> Preprocessor> Material Props> Material Models**
2. (double-click) "Structural", then "Linear", then "Elastic", then "Isotropic"

3. "EX" = 38000
4. "PRXY" = 0.3
5. [OK]
6. (double-click) "Density"
7. "DENS" = 8.3e-5
8. [OK]
9. **Material> Exit**

8.1.5. Generate Mesh

8.1.5.1. Step 4: Define element types.

Define two element types: a 2-D element and a 3-D element. Mesh the wing cross-sectional area with 2-D elements, and then extrude the area to create a 3-D volume. The mesh will be "extruded" along with the geometry so 3-D elements will automatically be created in the volume.

1. **Main Menu> Preprocessor> Element Type> Add/Edit/Delete**
2. [Add...]
3. "Structural Solid" (left column)
4. "Quad 4node 42" (right column)
5. [Apply] to choose the Quad 4 node (PLANE42)
6. "Structural Solid" (left column)
7. "Brick 8node 45" (right column)
8. [OK] to choose the Brick 8 node (SOLID45)
9. [Close]
10. Toolbar: **SAVE_DB**

8.1.5.2. Step 5: Mesh the area.

The next step is to specify mesh controls in order to obtain a particular mesh density.

1. **Main Menu> Preprocessor> Meshing> Mesh Tool**
2. "Size Controls Global" = [Set]
3. "Element edge length" = 0.25
4. [OK]
5. [Mesh]
6. [Pick All]
7. [Close] Warning.

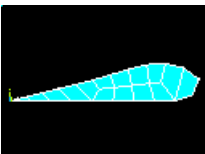

8. [Close] Meshtool
9. Toolbar: **SAVE_DB**

In designing this problem, the maximum node limit of ANSYS ED was taken into consideration. That is why the 4-node PLANE42 element, rather than the 8-node PLANE82 element was used. Note that the mesh contains a PLANE42 triangle, which results in a warning. If you are not using ANSYS ED, you may use PLANE82 during the element definitions to avoid this message. Note however that PLANE82 does not work unless you get rid of the Global Element edge length (which was set to 0.25).

Note

The mesh you see on your screen may vary slightly from the mesh shown above. As a result of this, you may see slightly different results during postprocessing. For a discussion of results accuracy, see [Planning Your Approach](#) in the *Modeling and Meshing Guide*.

8.1.5.3. Step 6: Extrude the meshed area into a meshed volume.

In this step, the 3-D volume is generated by first changing the element type to SOLID45, which is defined as element type 2, and then extruding the area into a volume.

1. **Main Menu > Preprocessor > Modeling > Operate > Extrude > Elem Ext Opts**
2. (drop down) "Element type number" = 2 SOLID45
3. "No. Elem divs" = 10
4. [OK]
5. **Main Menu > Preprocessor > Modeling > Operate > Extrude > Areas > By XYZ Offset**
6. [Pick All]
7. "Offsets for extrusion" = 0, 0, 10
8. [OK]
9. [Close] Warning.

Using SOLID45 to run this problem in ANSYS ED will produce this warning message. If ANSYS ED is not being used, then SOLID95 (20-node brick) can be used as element type 2. Using PLANE82 and SOLID95 produces a warning message about shape warning limits for 10 out of 127 elements in the volume.

10. **Utility Menu > PlotCtrls > Pan, Zoom, Rotate**
11. [Iso]
12. [Close]

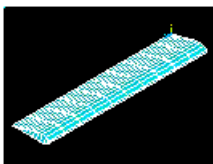

13. Toolbar: **SAVE_DB**

8.1.6. Apply Loads

8.1.6.1. Step 7: Unselect 2-D elements.

Before applying constraints to the fixed end of the wing, unselect all **PLANE42** elements used in the 2-D area mesh since they will not be used for the analysis.

1. **Utility Menu > Select > Entities**
2. (first drop down) "Elements"
3. (second drop down) "By Attributes"
4. (check) "Elem type num"
5. "Min,Max,Inc" = 1
6. (check) "Unselect"
7. [Apply]

8.1.6.2. Step 8: Apply constraints to the model.

Constraints will be applied to all nodes located where the wing is fixed to the body. Select all nodes at $z = 0$, then apply the displacement constraints.

1. (first drop down) "Nodes"
2. (second drop down) "By Location"
3. (check) "Z coordinates"
4. "Min,Max" = 0
5. (check) "From Full"
6. [Apply]
7. **Main Menu > Preprocessor > Loads > Define Loads > Apply > Structural > Displacement > On Nodes**
8. [Pick All] to pick all *selected* nodes.
9. "DOFs to be constrained" = All DOF
10. [OK] Note that by leaving "Displacement" blank, a default value of zero is used.

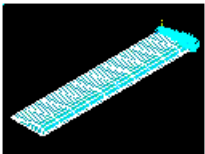

Now, reselect all nodes.

11. (second drop down) "By Num/Pick"
12. [Sele All] to immediately select all nodes from entire database.
13. [Cancel] to close dialog box.
14. Toolbar: **SAVE_DB**

8.1.7. Obtain Solution

8.1.7.1. Step 9: Specify analysis type and options.

Specify a modal analysis type.

1. **Main Menu> Solution> Analysis Type> New Analysis**
2. (check) "Modal"
3. [OK]
4. **Main Menu> Solution> Analysis Type> Analysis Options**
5. (check) "Block Lanczos" (Block Lanczos is the default for a modal analysis.)
6. "No. of modes to extract" = 5
7. "No. of modes to expand" = 5
8. [OK]
9. [OK] All default values are acceptable for this analysis.
10. Toolbar: **SAVE_DB**

8.1.7.2. Step 10: Solve.

1. **Main Menu> Solution> Solve> Current LS**
2. Review the information in the status window, then choose:
File> Close (Windows),
or
Close (X11 / Motif), to close the window.
3. [OK] to initiate the solution.
4. [Yes]
5. [Yes]

Based on previous discussions, the warnings are accepted. The messages presented in the verification window are due to the fact that **PLANE42** elements have been defined but not used in the analysis. They were used to mesh a 2-D cross-sectional area.

6. [Close] to acknowledge that the solution is done.

8.1.8. Review Results

8.1.8.1. Step 11: List the natural frequencies.

1. **Main Menu> General Postproc> Results Summary**
2. [Close] after observing the listing.

8.1.8.2. Step 12: Animate the five mode shapes.

Set the results for the first mode to be animated.

1. **Main Menu> General Postproc> Read Results> First Set**

2. **Utility Menu> PlotCtrls> Animate> Mode Shape**

3. [OK]

Observe the first mode shape:

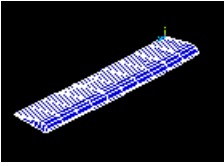

4. Make choices in the Animation Controller (not shown), if necessary, then choose Close.

Animate the next mode shape.

5. **Main Menu> General Postproc> Read Results> Next Set**

6. **Utility Menu> PlotCtrls> Animate> Mode Shape**

7. [OK]

Observe the second mode shape:

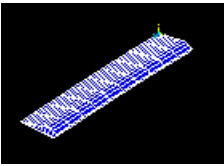

Repeat red steps 4 through 7 above, and view the remaining three modes.

Observe the third mode shape:

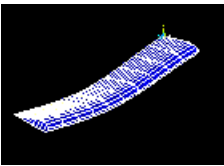

Observe the fourth mode shape:

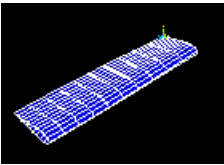

Observe the fifth mode shape:

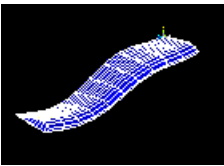

8.1.8.3. Step 13: Exit the ANSYS program.

1. Toolbar: **QUIT**
2. (check) "Quit - No Save!"
3. [OK]

Congratulations! You have completed this tutorial.

Even though you have exited the ANSYS program, you can still view animations [using the ANSYS ANIMATE program](#). The ANIMATE program runs only on the PC and is extremely useful for:

- Viewing ANSYS animations on a PC regardless of whether the files were created on a PC (AVI files) or on a UNIX workstation (ANIM files).
- Converting ANIM files to AVI files.
- Sending animations over the web.

Chapter 9: Probabilistic Design System (PDS) Tutorial

Probabilistic Design of a Simple Plate with a Single Force Load

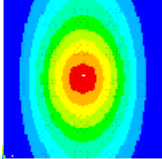

- Problem Specification
- Problem Description
- Specify Analysis File
- Define Input and Output
- Obtain Solution
- Perform Postprocessing
- Generate Report

9.1. Probabilistic Design of a Simple Plate with a Single Force Load

9.1.1. Problem Specification

Applicable ANSYS Products:	ANSYS Multiphysics, ANSYS Mechanical, ANSYS Structural, ANSYS ED
Level of Difficulty:	moderate
Interactive Time Required:	approximately 30 minutes
Discipline:	structural
Analysis Type:	static, linear
Element Types Used:	SHELL63
ANSYS Features Demonstrated:	Probabilistic Design System (PDS) Analysis
Applicable Help Available:	Probabilistic Design in the <i>Advanced Analysis Techniques Guide</i> , SHELL63 in the <i>Element Reference</i> .

9.1.2. Problem Description

This is a structural probabilistic analysis of a square plate fixed on two sides and loaded in the center, as shown below.

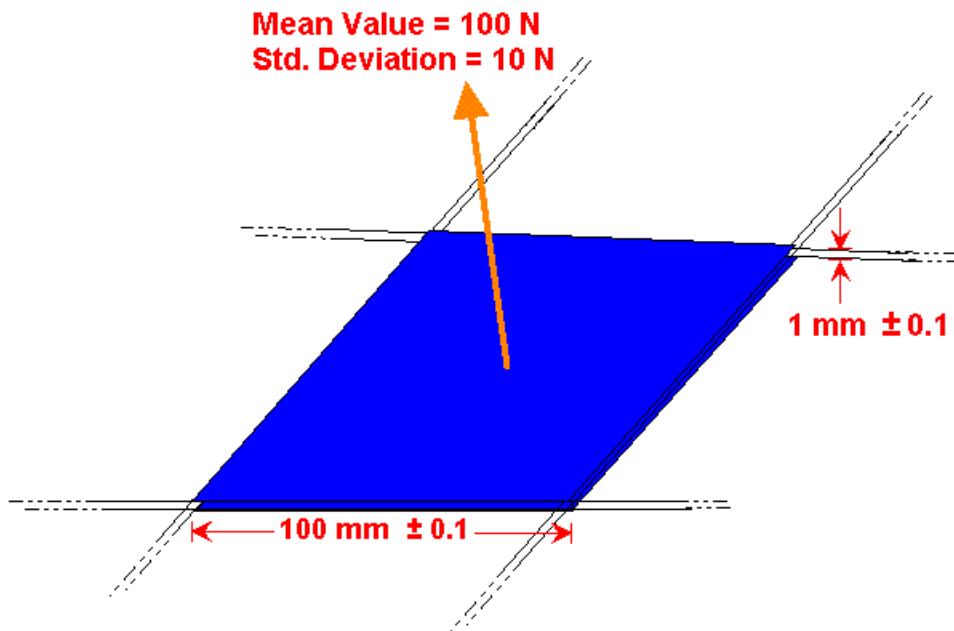

The input parameters are subject to uncertainty. Measurements show that the plate dimensions can vary significantly. Specimen tests show that the material properties can also vary. The applied force is also subject to uncertainty.

You will determine the variation of the output parameters given the uncertainty of the plate dimensions, material properties, and applied force. The output parameters that you will study are the maximum deflection of the plate and the maximum equivalent stress at the clamped edges.

The following are your main objectives:

- Review statistical results to determine if enough simulation loops have been performed.
- Determine the probability that the maximum deflection remains below a specified value.
- Determine the maximum deflection that will give a specified probability that the deflection is below that value.
- Quantify how sensitive the results are with respect to the variability of the input parameters.
- Produce scatter plots for the output parameters as a function of the most important random input variables.
- Determine the correlation coefficients between the output parameters and input variables.

9.1.2.1. Given

You are given an input file for a deterministic analysis of the plate, where uncertainties have been ignored. The square plate is 100 mm long and 1.0 mm thick. Young's modulus and density are equal to the values shown in the table below. The force is 100.0 N.

The manufacturing process produces plates with an accuracy of $\pm 0.1 \text{ mm}$.

The following are the material properties.

Material Property	Nominal Value	Distribution
Young's modulus	210.0 N/mm ²	Gaussian

		Standard deviation 3 - 5%
Density	8.0e-6 kg/mm ³	Uniform Standard deviation 5%

The force can only be positive and has a standard deviation of 10% of its mean value.

9.1.2.2. Approach and Assumptions

For this problem, you first enter the Probabilistic Design System (PDS), execute the file for the deterministic model and then specify it as the [analysis file](#) for the probabilistic analysis.

Next, you define the [random input variables](#) and [random output parameters](#) for your probabilistic analysis. For this problem, you define the length and thickness of the plate, Young's modulus and density, and force as random input variables with various distribution functions. You will define length and width as a [uniform distribution](#) with lower and upper bounds based on the manufacturing accuracy of ± 0.1 mm. To be conservative, you will use a 5% standard deviation for the Young's modulus. To demonstrate that density has no significant impact on the results, you will use a uniform distribution from 50% to 150% of its nominal value. For force, you will use a [lognormal distribution](#) with a mean value equal to the nominal value and a [standard deviation](#) of 10% of its mean value. You define the maximum deflection and maximum equivalent stress at the fixed edges as the output parameters.

Next, you define [Monte Carlo](#) as the probabilistic analysis method and execute the Monte Carlo [probabilistic simulations](#).

Finally, you visualize and evaluate the Monte Carlo results to achieve the analysis objectives, as stated above.

9.1.2.3. Summary of Steps

Use the information in the problem description and the steps below as a guideline in solving the problem on your own. Or, use the detailed interactive step-by-step solution by choosing the link for step 1.

Specify Analysis File

1. [Enter PDS and specify analysis file.](#)

Define Input and Output

2. [Define input variables.](#)
3. [Define output parameters.](#)

Obtain Solution

4. [Execute Monte Carlo simulations.](#)

Perform Postprocessing

5. [Perform statistical postprocessing.](#)
6. [Perform trend postprocessing.](#)

Generate Report

7. Generate HTML report and exit.

9.1.3. Specify Analysis File

9.1.3.1. Step 1: Enter PDS and specify analysis file.

You begin by entering the Probabilistic Design System (PDS) and executing the file `plate.mac` for the deterministic model. The `plate.mac` file contains a complete analysis sequence for a simple plate with a single force load. It uses parameters to define all inputs and outputs. If you are using the UNIX version of ANSYS, the file resides at `/ansys_inc/v121/ansys/data/models`. If you are using the PC version of ANSYS, the file resides at `\Program Files\Ansys Inc\V121\ANSYS\data\models`. Before performing substep 1 below, it is highly recommended that you copy the file `plate.mac` to your working directory.

1. **Main Menu> Prob Design**
2. **Utility Menu> File> Read Input from**
3. File name: `plate.mac`
4. [OK]
5. [Close]

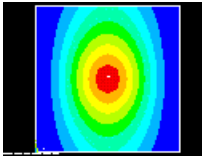

Now define `plate.mac` as the analysis file for the probabilistic analysis. PDS uses `plate.mac` to create a file for performing analysis loops. PDS uses the `plate.mac` input and output parameters as random input variables (RVs) and random output parameters (RPs).

6. **Main Menu> Prob Design> Analysis File> Assign**
7. File name: `plate.mac`
8. [OK]

9.1.4. Define Input and Output

9.1.4.1. Step 2: Define input variables.

You will now define the input parameters and their distribution functions.

1. **Main Menu> Prob Design> Prob Definitns> Random Input**
2. [Add...]
Define length as an input variable.
3. "Select a Parameter" = LENGTH
4. "Distribution Type" = Uniform
5. [OK]
6. "Lower Boundary" = LENGTH-0.1

7. "Upper Boundary" = $\text{LENGTH}+0.1$

8. [OK]

9. [Add...]

Define thickness as an input variable.

10. "Select a Parameter" = THICKNESS

11. "Distribution Type" = Uniform

12. [OK]

13. "Lower Boundary" = $\text{THICKNESS}-0.1$

14. "Upper Boundary" = $\text{THICKNESS}+0.1$

15. [OK]

16. [Add...]

Define Young's modulus as an input variable.

17. "Select a Parameter" = YOUNG

18. "Distribution Type" = Gauss

19. [OK]

20. "Mean value" = YOUNG

21. "Standard deviation" = $0.05*\text{YOUNG}$

22. [OK]

23. [Add...]

Define density as an input variable.

24. "Select a Parameter" = DENSITY

25. "Distribution Type" = Uniform

26. [OK]

27. "Lower Boundary" = $0.5*\text{DENSITY}$

28. "Upper Boundary" = $1.5*\text{DENSITY}$

29. [OK]

30. [Add...]

Define force as an input variable.

31. "Select a Parameter" = FORCE

32. "Distribution Type" = LOG1

33. [OK]

34. "Mean value" = FORCE

35. "Standard deviation" = $0.1*\text{FORCE}$

36. [OK]

37. [Close]

9.1.4.2. Step 3: Define output parameters.

You will now define the maximum deflection of the plate and the maximum equivalent stress at the clamped edges as output parameters.

1. **Main Menu> Prob Design> Prob Definitns> Random Output**
2. [Add...]
3. "Select Parameter" = MAXDEFLECTION
4. [OK]
5. [Add...]
6. "Select Parameter" = MAXSTRESS
7. [OK]
8. [Close]

9.1.5. Obtain Solution

9.1.5.1. Step 4: Execute Monte Carlo simulations.

You will now specify the Monte Carlo Simulation method and various options. You will specify the [Latin Hypercube sampling](#) technique. For the same accuracy, it generally requires fewer simulation loops than the Direct Monte Carlo Sampling technique. You will set the number of simulations to 40 and the number of repetitions to 1 to give 40 analysis loops. Forty loops will be a sufficient number for demonstration purposes. You will also set a few special options. For more information on the Monte Carlo Simulation method and these options, refer to the **PDMETH** and **PDLHS** commands in the [Command Reference](#) and [Probabilistic Design](#) in the [Advanced Analysis Techniques Guide](#).

1. **Main Menu> Prob Design> Prob Method> Monte Carlo Sims**
2. "Latin Hypercube"
3. [OK]
4. "Number of Simulations" = 40
5. "Number of Repetitions" = 1
6. "Random Sampling"
7. "Execute ALL Sims"
8. "Use 123457 INIT"
9. [OK]
10. **Main Menu> Prob Design> Run> Exec Serial> Run Serial**
11. "Solution Set Label" = LHSRUN
12. [OK]
13. Review the information in the dialog box, then [OK] to initiate the solution.

The solution is complete when the statement "LOOP 40 OUT OF 40 - CYCLE 1 OUT OF 1 IS FINISHED" appears in the ANSYS Output Window.

9.1.6. Perform Postprocessing

9.1.6.1. Step 5: Perform statistical postprocessing.

You will now review simulation results and mean value plots for maximum deflection. If the number of simulations is sufficient, the mean value plots for random output variables converge (the curve flattens out).

You will also review a histogram plot for the maximum deflection in order to visualize the scatter of this random output parameter. To double check that the number of simulation loops is sufficient, you will plot a histogram of the Young's modulus random input variable. The ANSYS PDS not only plots the histogram bars, but also plots a curve for values derived from the distribution function that you specified. If the number of simulations is sufficient, the histogram for Young's modulus will have bars close to the curve derived for the distribution function, which are smooth and without any major gaps.

You will also determine the following:

- The probability that the maximum deflection is below 0.525 mm.
- The maximum deflection that will give a 90% probability that the deflection is below that value.

1. **Main Menu> Prob Design> Prob Results> Statistics> Sampl History**
2. "Prob Design Variable" = MAXDEFLECTION
3. "Samples"
4. [OK]

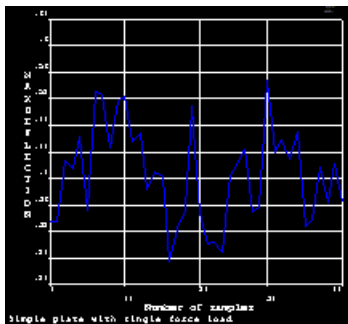

5. **Main Menu> Prob Design> Prob Results> Statistics> Sampl History**
6. "Prob Design Variable" = MAXDEFLECTION
7. "Mean values"
8. [OK]

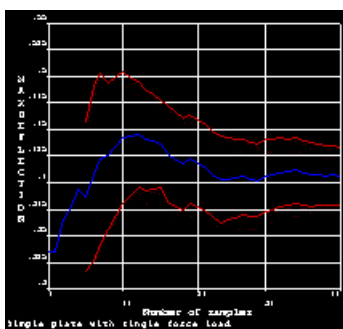

The curve is relatively flat, indicating that the number of simulations is sufficient.

9. **Main Menu> Prob Design> Prob Results> Statistics> Histogram**

10. "Prob Design Variable" = MAXDEFLECTION

11. [OK]

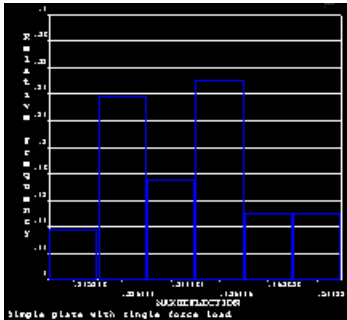

12. **Main Menu> Prob Design> Prob Results> Statistics> Histogram**

13. "Prob Design Variable" = YOUNG

14. [OK]

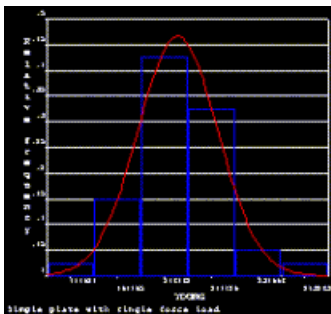

The histogram bars resemble the probability density function, indicating that the number of simulations is sufficient.

15. **Main Menu> Prob Design> Prob Results> Statistics> CumulativeDF**

16. "Prob Design Variable" = MAXDEFLECTION

17. [OK]

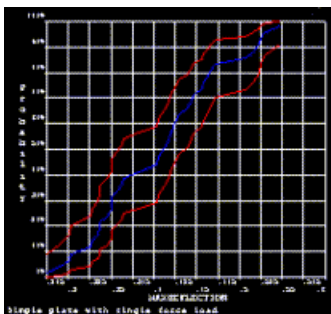

The curve shows that there is a about a 93% probability that the deflection remains below 0.525.

18. **Main Menu> Prob Design> Prob Results> Statistics> Probabilities**

19. "Prob Design Variable" = MAXDEFLECTION

20. "Less than"

21. "Limit Value" = 0.525

22. [OK]

Note that the probability is 93.026% that the maximum deflection is below the value of 0.525 mm.

23. After reviewing the information, **File> Close** (Windows platforms) or **Close** (UNIX platforms)

24. **Main Menu> Prob Design> Prob Results> Statistics> Inverse Prob**

25. "Prob Design Variable" = MAXDEFLECTION

26. "Target Probability" = 0.90

27. [OK]

Note that there is a 90% probability that the maximum deflection is below 0.5209 mm.

28. After reviewing the results, choose **File> Close** (Windows platforms) or **Close** (UNIX platforms).

You have achieved three of your six main objectives for running this tutorial as stated above in *Problem Description* (p. 107). In Step 5, you:

- Reviewed statistical results and determined that 40 simulation loops were sufficient (substeps 8 and 14).
- Determined that the probability of the maximum deflection being below 0.525 mm, is 93% (substeps 17 and 23).
- Determined that a deflection limit of 0.5209 mm should be specified to achieve a 90% probability that the deflection is below that value (substep 28).

9.1.6.2. Step 6: Perform trend postprocessing.

You will now request sensitivity plots for MAXDEFLECTION and MAXSTRESS to determine which random input variables are most significant. You will then request scatter plots of MAXDEFLECTION and MAXSTRESS versus the most significant random input variables. Finally, you will determine the correlation coefficients between the random output parameters and the random input variables.

1. **Main Menu> Prob Design> Prob Results> Trends> Sensitivities**
2. Choose for the "Select Response Param" = MAXDEFLECTION
3. [OK]

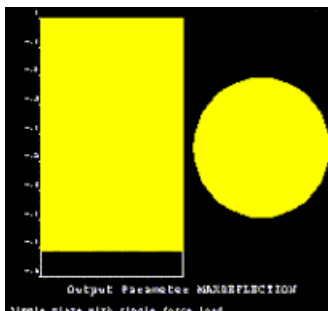

Note that the legend indicates that only the random input variable THICKNESS is important for the random output parameter MAXDEFLECTION.

```

Significant:
■ THICKNESS

Insignificant:
LENGTH
YOUNG
DENSITY
FORCE

Significance level:
2.500%
    
```

4. **Main Menu> Prob Design> Prob Results> Trends> Sensitivities**
5. "Select Response Param" = MAXSTRESS
6. [OK]

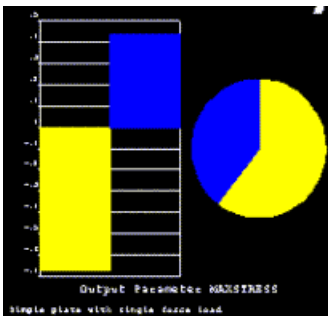

Note that the legend indicates that only the random input variables THICKNESS and FORCE are important for the random output parameter MAXSTRESS.

```

Significant:
■ THICKNESS
■ FORCE

Insignificant:
LENGTH
YOUNG
DENSITY

Significance level:
2.500%
    
```

7. **Main Menu> Prob Design> Prob Results> Trends> Scatter Plot**
8. "Name 1 Select Parameter" = THICKNESS
9. "Name 2 Select Parameter" = MAXDEFLECTION
10. [OK]

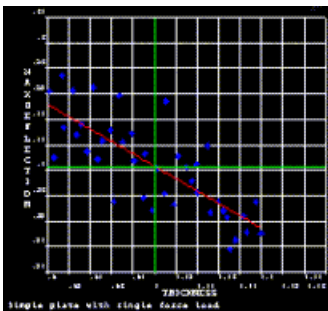

11. **Main Menu> Prob Design> Prob Results> Trends> Correl Matrix**
12. "Type of Matrix" = Input-Output

13. [OK]

14. [OK]

Note the correlation coefficients.

15. After reviewing the results, choose **File> Close** (Windows platforms) or **Close** (UNIX platforms).

You have achieved the remaining three of your six total main objectives for running this tutorial as stated above in *Problem Description* (p. 107). In Step 6, you:

- Determined that only the random input variable THICKNESS is important for the random output parameter MAXDEFLECTION (substep 3), and that only the random input variables THICKNESS and FORCE are important for the random output parameter MAXSTRESS (substep 6).
- Produced a scatter plot of the MAXDEFLECTION output parameter as a function of the THICKNESS input variable (substep 10).
- Determined correlation coefficients between output parameters MAXDEFLECTION and MAXSTRESS, and input variables LENGTH, THICKNESS, YOUNG, DENSITY, and FORCE (substep 15).

9.1.7. Generate Report

9.1.7.1. Step 7: Generate HTML report and exit.

You will now generate an HTML report for your probabilistic analysis. It includes deterministic model information, probabilistic model information, and probabilistic analysis results.

1. **Main Menu> Prob Design> Prob Results> Report> Report Options**
2. [OK] to use the default options.
3. **Main Menu> Prob Design> Prob Results> Report> Generate Report**
4. "Report file name" = Simple Plate Analysis
5. "Your first name" = John
6. "Your last name" = Doe
7. [OK]

You will find the report and all related files in your current directory in a subdirectory with the report file name.

8. Toolbar: **Quit**
9. "Quit - No Save!"
10. [OK]

Congratulations! You have completed this tutorial.

Chapter 10: ANIMATE Program

View Animations on a PC Using the ANIMATE program.

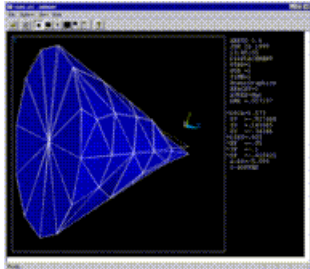

The ANIMATE program allows you to view ANSYS animation files on a PC regardless of whether the files were created on a PC (AVI files), or on a UNIX workstation (ANIM files). The program is truly standalone. You can run it without ANSYS even being installed. Also, its small 250kB file size makes it easy to transport as an e-mail attachment, if required.

If you create and view AVI animation files on a PC, the ANIMATE program will provide you with better frame speed and window size control than if you use the Windows Media Player. For ANIM files created on UNIX workstations, you not only can view the files directly on a PC using the ANIMATE program, but you can also *convert* an ANIM file to an AVI file. This provides a substantial reduction in file size -- ideal for producing downloadable animation files for the web. Also, when using the ANIMATE program to view 3-D model animations saved as ANIM files, you can pan, zoom, or rotate the model (using the mouse buttons) *while* the animation is in progress.

The following procedure will allow you to exercise some of the features of the ANIMATE program. To perform the procedure, you must be using a PC and have an AVI or ANIM animation file stored locally on your Windows file system.

Note

If you created an animation in ANSYS, you can save the animation to a file and assign it any name from the Utility Menu, PlotCtrls, Animate, Save Animation, then assign a file name. Any animation file saved this way can be used in the ANIMATE program.

For ANIM files in a UNIX file system, you must transfer the ANIM files to the Windows file system using the FTP protocol, SAMBA, or some other file system transfer utility. Another requirement for using the ANIMATE program is that the ANIM file must have been created using pixmap animation as opposed to display list animation. On a UNIX workstation, you can set this in ANSYS from the Utility Menu by choosing PlotCtrls, Device Options, then checking Pixmap for Animation mode in the dialog box.

After you have fulfilled the requirements stated above, exercise some of the features of the ANIMATE program as follows:

1. With the ANSYS CD in your CD drive, open a Windows file manager (e.g.,



Windows Explorer) and obtain a listing of file names in the root directory of the CD.

2. Start the file named `Animate.exe`.

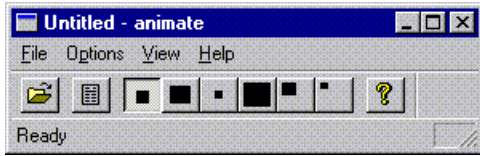

3. Click on the **Open file** button. →
4. From the file selection list, choose any AVI animation file, or an ANIM animation file created using the pixmap animation.

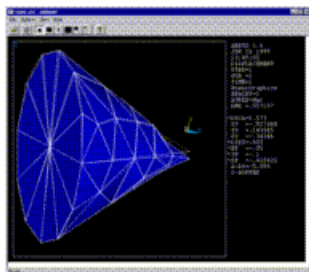

5. Display the Animation Controller by clicking on the **Controller** button. →

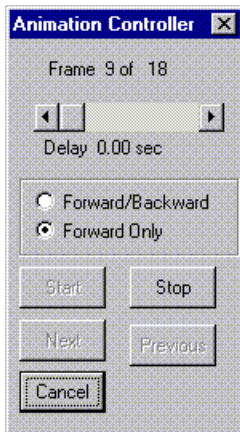

6. Experiment with the various controls on the Animation Controller.
7. With the animation still running, experiment with different window sizes by clicking on the various window buttons located on the toolbar. →
8. If you are viewing an AVI file, you have completed this procedure. Choose **File > Exit** → to terminate the ANIMATE program. If you are viewing an ANIM file, continue with the remaining steps below.

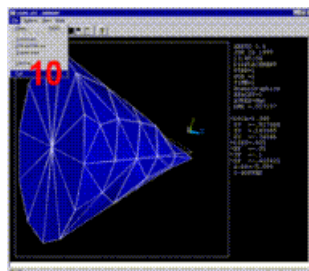
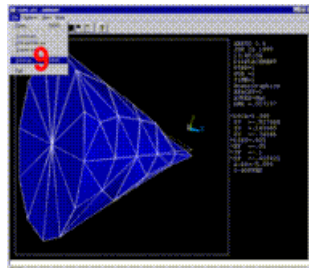
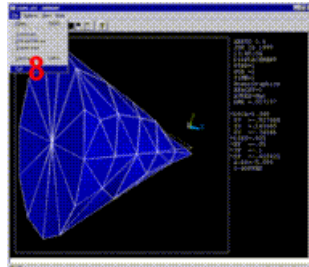
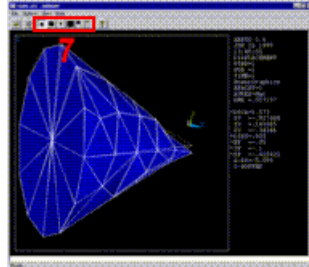
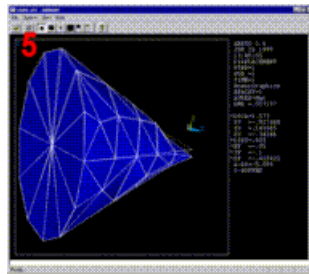

9. Convert the ANIM file to an AVI file by choosing **File > Save as** → then specifying a file name, and clicking on **Save**.
10. Terminate the ANIMATE program by choosing **File > Exit**. →
11. From your Windows file manager, compare the size of the original ANIM file with the size of the AVI file you just converted. Note the substantial reduction in file size resulting from the conversion.

